

# 5.03

Grubber  
Harver

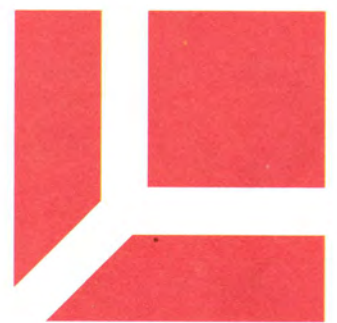

**GRENE**



## Indholdsfortegnelse

3.002

Granatharvetand .....	3.060	Rotorharver	
Harve & grubber		Amazone .....	3.049
Agrodan .....	3.043	Befa .....	3.054
Baryton .....	3.027	Bomford .....	3.058
Becker .....	3.047	Dondi .....	3.053
Befa .....	3.019	Euroma .....	3.055
Bovlund .....	3.046	Falc .....	3.053
Dalbo - Præstbro helmnedmulder .....	3.028	Hankmo .....	3.058
Dalbo Multiflex .....	3.027	Howard .....	3.059
Doublet Rekord .....	3.011	Köckerling .....	3.053
Egebak .....	3.047	Kongskilde .....	3.054
Flemstofte .....	3.033	Krone .....	3.052
Franquet .....	3.027	Kuhn .....	3.051
Howard-Delta .....	3.046	Landsberg .....	3.052
JOS .....	3.027	Landsberg .....	3.054
Kongskilde .....	3.003	Lely .....	3.052
Kverneland, Fraugde .....	3.029	Maletti/Kverneland .....	3.053
Langeskov .....	3.023	Maletti/Kverneland .....	3.054
Lemken-Smaragd .....	3.046	Maschio .....	3.053
Lilla - Harrie .....	3.036	Niemeyer .....	3.055
Marsk Stig .....	3.038	Omme .....	3.058
Multiplex .....	3.023	Pergoraro .....	3.054
Omme .....	3.023	Rabe .....	3.056
Prela .....	3.026	Rau .....	3.052
Primoplex .....	3.019	Rau .....	3.054
Rabe .....	3.046	Simca .....	3.054
Sdr. Omme .....	3.019	Vogel & Noot, serie M .....	3.053
Solbjerg .....	3.047	Vogel & Noot .....	3.054
Sporløsnertænder .....	3.037	Spidsharvetænder .....	3.060
Tip-Top .....	3.023	Spændestykker .....	3.083
Väderstad .....	3.024	Tallerkenharver	
Viberg .....	3.025	Doublet Rekord .....	3.061
Kvikliste		Fiskars .....	3.062
Efterharvetænder .....	3.080	Kverneland .....	3.062
Grubberspidser .....	3.071	Sdr. Omme .....	3.062
Halmnedmuldere .....	3.075	Stegsted .....	3.062
Jernballonhjul .....	3.084	Ukrudtsharvetand .....	3.060
Kulturharvespidser .....	3.064	Ukrudtsstrigler	
Kulturharvetænder .....	3.076	Doublet Rekord .....	3.063
Stubharvespidser/remseskær .....	3.066	Einböck .....	3.063
Stubkultivatortænder .....	3.080	Hatzenbichler .....	3.063
		Köckerling .....	3.063

## Kulturharvetænder

3.003

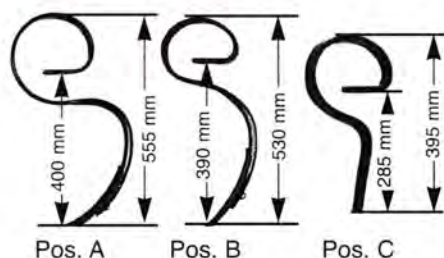

Pos.	Benævnelse	Original	Uoriginal	Anv. på pos.	Pk/bdt.str. eller løse	Grp.-varenummer
A	S-tand m/spids, 32 x 10 mm	x			6	5125-01000669
A	S-tand m/spids, 32 x 10 mm		x		6	5110-1013
A	S-tand m/spids, 32 x 12 mm		x		6	5110-1072
A	S-tand u/spids, 32 x 10 mm		x		løs	5110-300001
B	Super Q-tand m/spids, anv. også som sporløsnerstand på Germinator	x			løs	5125-01000740
C	Germinatort. m/spids, 32 x 10 mm	x			løs	5125-01200236
C	Germinatort. m/spids, 32 x 10 mm		x		løs	5110-01200236

## Spidser til kulturharvetænder



Pos.	Benævnelse	Original	Uoriginal	Anv. på pos.	Pk/bdt.str. eller løse	Grp.-varenummer
1	Spids m/bolt, blå, 6 mm	x		A & B	50	5125-01000640
1	Spids m/bolt, blå, 6 mm		x	A & B	25	5120-1
1	Spids m/bolt, blå, 6 mm		x	A & B	25	5120-10-130/625
1	Spids m/bolt, sort, 8 mm		x	A & B	25	5120-10-130/8
1	Spids m/bolt, grøn, 6 mm	x		A & B	25	5125-01000583
2	Sporløsnerspids m/bolt	x		A & B	18	5125-01000646
3	Gåsefodslap, 7 cm m/bolt, sort	x		A & B	50	5125-01000642
3	Gåsefodslap, 7 cm m/bolt, blå, ultra	x		A & B	50	5125-01000650
3	Gåsefodslap, 7 cm u/bolt, blå, ultra		x	A & B	25	5140-10-131/6
4	Renseskær m/bolt, 10,5 cm, sort	x		A & B	50	5125-01000644
4	Renseskær u/bolt, 10,5 cm, sort		x	A & B	25	5140-10-132/4
5	Dobb. spids m/bolt, sort	x		A & B	10	5125-01000652
6	Germinatorspids m/bolt, sort, 6 mm	x		C	50	5125-01200229
6	Germinatorspids m/bolt, blå, 8 mm		x	C	25	5120-A4
7	Sporløsnerspids m/bolt, sort, 6 mm	x		C	10	5125-01200231
8	Renseskær u/bolt, 18 cm, sort, 5 mm	x		A & B	25	5140-10-133/5
8	Renseskær u/bolt, 15 cm, sort, 4 mm	x		A & B	25	5140-A30

## Bolt for spidser

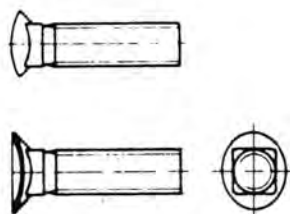

Pos.	Benævnelse	Original	Uoriginal	Anv. på pos.	Pk/bdt.str. eller løse	Grp.-varenummer
	Radrenserbolt, M10 x 37, Kv. 8.8 eller Radrenserbolt, M10 x 40, Kv. 8.8		x		100	5003-1037
	Radrenserbolt, M10 x 40, Kv. 8.8		x		100	5003-1040

## Spændestykker



1	Spændestykke m/motrik, t/S-tand	x		A & C	25	5125-01000507
1	Spændestykke t/Super Q-tand	x		B	25	5125-01000742
2	Spændestykke t/S-tand		x	A & C	25	5110-10-004
2	Spændestykke t/5110-1072		x	A	25	5110-10-006
	Bolt for 5110-10-004, M12 x 45		x		100	0210-12045



## Rækkerensere

3.004

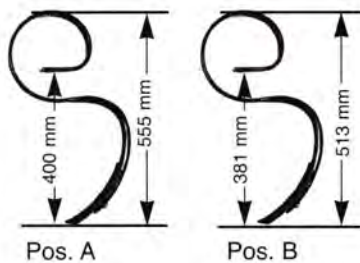

### Til Vibro-Corn & Vibro-Beta

Pos.	Benævnelse	Original	Uoriginal	Anv. på pos.	Pk/bdt.str. eller løse	Grp.-varenummer
A	S-tand, anv. til 1995, 32 x 10 mm	x			6	<b>5125-01000669</b>
A	S-tand, anv. til 1995, 32 x 10 mm		x		6	<b>5110-1013</b>
A	S-tand, anv. til 1995, 32 x 10 mm		x		løs	<b>5110-300001</b>
B	VCO-tand m/01019785, anv. f/1995	x			løs	<b>5125-01000760</b>

## Skær



### Til Vibro-Corn & Vibro-Beta rækkerensere

Pos.	Benævnelse	Original	Uoriginal	Anv. på pos.	Pk/bdt.str. eller løse	Grp.-varenummer
1	Renseskær m/bolt, 13,5 cm	x		A & B	20	<b>5125-01019785</b>
1	Renseskær u/bolt, 13,5 cm		x	A & B	25	<b>5120-10-143</b>
2	Renseskær m/bolt, 20,0 cm	x		A & B	10	<b>5125-01019786</b>
2	Renseskær u/bolt, 20,0 cm		x	A & B	25	<b>5120-10-144</b>

## Bolt til skær

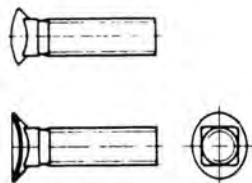

Pos.	Benævnelse	Original	Uoriginal	Anv. på pos.	Pk/bdt.str. eller løse	Grp.-varenummer
	Radrenserbolt, M10 x 37, Kv. 8.8		x		100	<b>5003-1037</b>

## Spændestykker



### Til Vibro-Corn & Vibro-Beta

Pos.	Benævnelse	Original	Uoriginal	Anv. på pos.	Pk/bdt.str. eller løse	Grp.-varenummer
1	Spændestykke m/møtrik	x		A	25	<b>5125-01000507</b>
1	Spændestykke	x		B	25	<b>5125-01000742</b>
2	Spændestykke		x	A	25	<b>5110-10-004</b>

## Rulleskær & nav

3.005

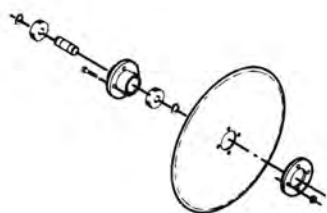

### Til Vibro-Corn & Vibro-Beta

Pos.	Benævnelse	Original	Uoriginal	Anv. på pos.	Pk/bdt.str. eller løse	Grp.-varenummer
	Rulleskær, Ø460 mm	x			løs	<b>5125-01019364</b>
	Nav kpl. t/rulleskær	x			løs	<b>5125-01017397</b>
	Nylonlejobøsning	x			løs	<b>5125-01019155</b>
	Leje i nav, 2 stk.		x		løs	<b>7500-6205-2RS</b>

## Bøsninger

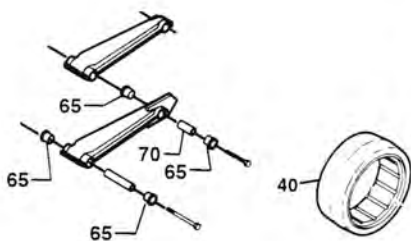

### Ved arme til halvmassivhjul

Pos.	Benævnelse	Original	Uoriginal	Anv. på pos.	Pk/bdt.str. eller løse	Grp.-varenummer
70	Afstandsrør, kort	x			løs	<b>5125-01017977</b>
65	Nylonleje	x			løs	<b>5125-01017013</b>
40	Dæk, 12 x 4", halvmassiv	x			løs	<b>5125-01019111</b>

## Stubharver

3.006

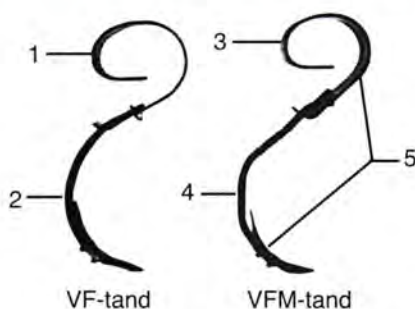

### Til Vibroflex

Pos.	Benævnelse	Original	Uoriginal	Anv. på pos.	Pk/bdt.str. eller løse	Grp.-varenummer
1	Overfjeder t/VF-tand - se 1)	x			løs	5125-05000002
2	Fjederstilk t/VF-tand u/spids	x			løs	5125-05000128
3	Overfjeder t/VFM-tand - se 2)	x			løs	5125-05150055
4	Fjederstilk t/VFM-tand u/spids	x			løs	5125-05150056
5	VFM-tand m/Ultra-muldsvær, kpl.	x			løs	5125-05150135

1) Godstykkelse 10 mm, trekantet hul v/samling af over- og underdel

2) Godstykkelse 12 mm, aflangt hul v/samling af over- og underdel

## Spidser til stubtænder

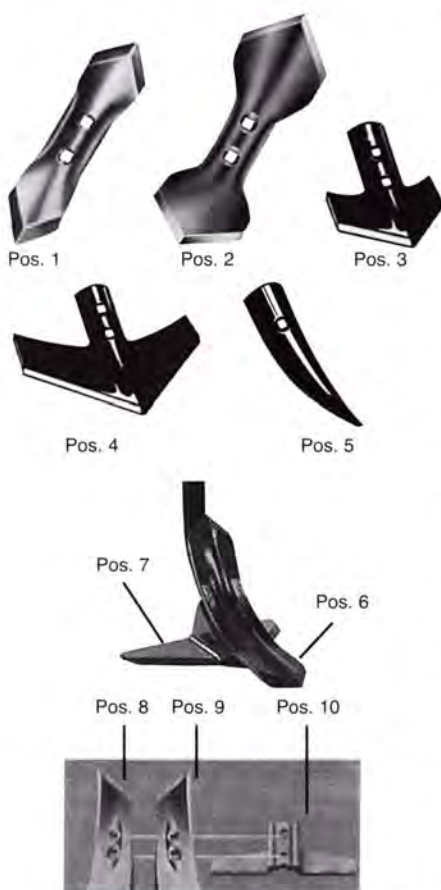

Pos.	Benævnelse	Original	Uoriginal	Anv. på pos.	Pk/bdt.str. eller løse	Grp.-varenummer
1	Vibroflex, 2 1/2" m/bolte, 8mm, blå	x		Alle	20	5125-05000504
1	Vibroflex, 2 1/2" m/bolte, 8mm, blå		x	Alle	20	5140-40004-820
1	Vibroflex, 2 1/2" u/bolte, 8mm, blå		x	Alle	10	5140-A45
2	Vibroflex, 4" m/bolt, 8 mm, blå	x		Alle	10	5125-05000514
2	Vibroflex, 4" m/bolt, 6 mm, sort	x		Alle	10	5125-05000485
2	Vibroflex, 4" m/bolt, 8 mm, blå		x	Alle	10	5140-40005-810
2	Vibroflex, 4" u/bolt, 8 mm, blå		x	Alle	10	5140-A10
3	Planskær 5", m/bolt, 6 mm, sort	x		Alle	20	5125-05000486
4	Planskær 10", m/bolt, 6 mm, sort	x		Alle	10	5125-05000487
4	Planskær 10", m/bolt, 8 mm, blå	x		Alle	10	5125-05000584
4	Sweepeskær, 7" m/bolt, 8 mm	x		Alle	10	5125-01000553
5	Græsspids m/bolt, 6 mm, sort	x		Alle	25	5125-05000488
6	Mixing-spids 8 cm, m/12 x 55 mm bolt, 8 mm, blå	x		Alle	20	5125-05000649
7	Mixing-vingeskær 26 cm, u/bolt, 6 mm, blå	x		Alle	10	5125-05000650
8	Solbj.syst., vr. spids H. u/bolt, sølv		x	Alle	løs	5140-60317
8	Solbj.syst., vr. spids H. m/bolt, sølv		x	Alle	10	5140-60317-10
9	Solbj.syst., vr. spids V. u/bolt, sølv		x	Alle	løs	5140-60316
9	Solbj.syst., vr. spids V. m/bolt, sølv		x	Alle	10	5140-60316-10
10	Solbjerg-system, vingskær, 28 cm, u/bolt, sølv - se 1)		x	Alle	løs	5140-60239
10	Solbjerg-system, vingskær, 28 cm, m/bolt, sølv - se 1)		x	Alle	10	5140-60239-10

1) "Åbningen" til tanden på vingskæret er ca. 55 mm

Vingskæret monteres mellem den vredne sølvspids og tanden





## Spidser til stubtænder

3.007

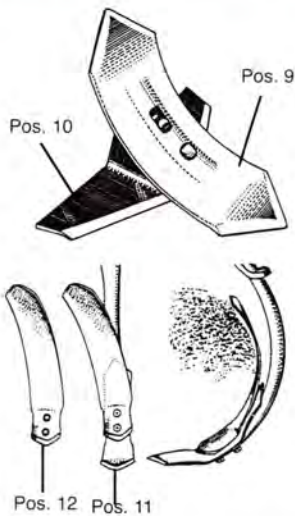

Pos.	Benævnelse	Original	Uoriginal	Anv. på pos.	Pk/bdt.str. eller løse	Grp.-varenummer
9	Stenst.syst. spids 110 mm u/bolt, blå		x	Alle	10	<b>5140-A15</b>
9	Stenst.syst. spids 65 mm u/bolt, blå		x	Alle	10	<b>5140-A16</b>
9	Stenst.syst. spids 50 mm u/bolt, blå		x	Alle	10	<b>5140-A17</b>
10	Stenst.syst. vingsk. 300 mm, u/bolt, blå		x	Alle	løs	<b>5140-A18</b>
11	Stenst.syst. Spids 2 1/2" u/bolt, blå		x	Alle	10	<b>5140-A45</b>
12	Stenst.syst. NON STOP u/bolt, blå		x	Alle	løs	<b>5140-A46</b>

## Bolt til stubspidser

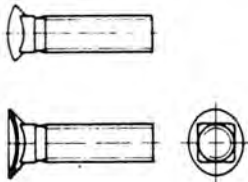

Pos.	Benævnelse	Original	Uoriginal	Anv. på pos.	Pk/bdt.str. eller løse	Grp.-varenummer
	Radrenserbolt M12 x 48 mm		x		50	<b>5125-00323128</b>

## Bolte

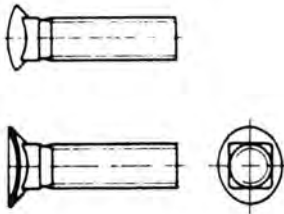

Til vingskær, systemspidser & vredne spidser t/vingskær

Pos.	Benævnelse	Original	Uoriginal	Anv. på pos.	Pk/bdt.str. eller løse	Grp.-varenummer
	Radrenserbolt M12 x 60 mm, Kv. 8.8 eller Radrenserbolt M12 x 70 mm, Kv. 8.8		x		25	<b>5003-1260</b>
			x		25	<b>5003-1270</b>

## Befæstigelse af tand



Pos.	Benævnelse	Original	Uoriginal	Anv. på pos.	Pk/bdt.str. eller løse	Grp.-varenummer
	Bolt og låsemøtrik f/samling af overfjeder og stilk, samt mont. på bulle		x	Alle	50	<b>0222-16045</b>
			x	Alle	50	<b>0444-16</b>

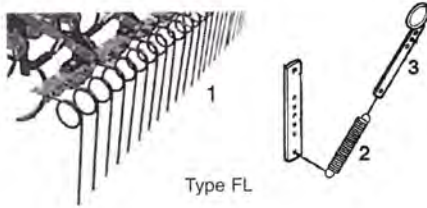

### FL-efterharvedele

Pos.	Benævnelse	Original	Uoriginal	Anv. på pos.	Pk/bdt.str. eller løse	Grp.-varenummer
1	FL-tand u/bolt Stålbolt M12 x 30 mm Spændeskive M12 Møtrik M12	x	x		25 100 100 100	<b>5125-02200065</b> <b>0222-12030</b> <b>0562-12</b> <b>0404-12</b>
2	Fjeder f/ophæng, 7,0 mm tråd	x			Løs	<b>5125-03120018</b>
2	Fjeder f/ophæng, 5,5 mm tråd	x			Løs	<b>5125-03120019</b>
3	Fjederstrammer	x			Løs	<b>5125-03120015</b>

### F-efterharvedele

Pos.	Benævnelse	Original	Uoriginal	Anv. på pos.	Pk/bdt.str. eller løse	Grp.-varenummer
	F-tand u/bolt Stålbolt M10 x 25 mm Stålbolt M10 x 35 mm	x	x		25 100 100	<b>5125-02010092</b> <b>0222-10025</b> <b>0222-10035</b>
	Stålbolt M10 x 40 mm Stålmøtrik M10		x		100 100	<b>0210-10040</b> <b>0404-10</b>

## Rotorsmuldrer

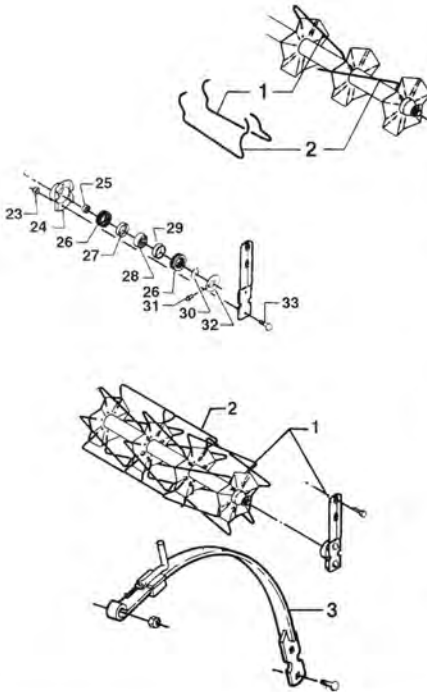

Pos.	Benævnelse	Original	Uoriginal	Anv. på pos.	Pk/bdt.str. eller løse	Grp.-varenummer
1	Smuldrebøjle, højre	x			24	<b>5125-03000486</b>
2	Smuldrebøjle, venstre Mont.-tang f/smuldrebøjle	x	x		24 løs	<b>5125-03000487</b> <b>5125-03000610</b>
	G-leje f/rotorsmuldre u/beslag (pos. 25-33 passer også på gl. model knivkors) Belastningsfjeder ved rotorsmuldrer	x			løs løs	<b>5125-03000454</b> <b>5125-03040111</b>

1	Smuldretr. m/leje arm 600 mm, 2 sek.	x			løs	<b>5125-03000431</b>
1	Smuldretr. m/leje arm 800 mm, 3 sek.	x			løs	<b>5125-03000432</b>
2	Smuldretr. u/leje arm 1000 mm, 4 sek.	x			løs	<b>5125-03000439</b>
2	Smuldretr. u/leje arm 1400 mm, 6 sek.	x			løs	<b>5125-03000441</b>
3	Fjeder m/håndtag	x			løs	<b>5125-05075028</b>

## Skrabejern



Pos.	Benævnelse	Original	Uoriginal	Anv. på pos.	Pk/bdt.str. eller løse	Grp.-varenummer
	16", venstre f/S 16", højre f/S - SGB 18", venstre f/S - SG	x			løs løs løs	<b>5125-01000091</b> <b>5125-01000079</b> <b>5125-01000162</b>
	18", højre f/S - SG - SGB Skrabejernsholder	x			løs	<b>5125-01000080</b> <b>5125-01050143</b>



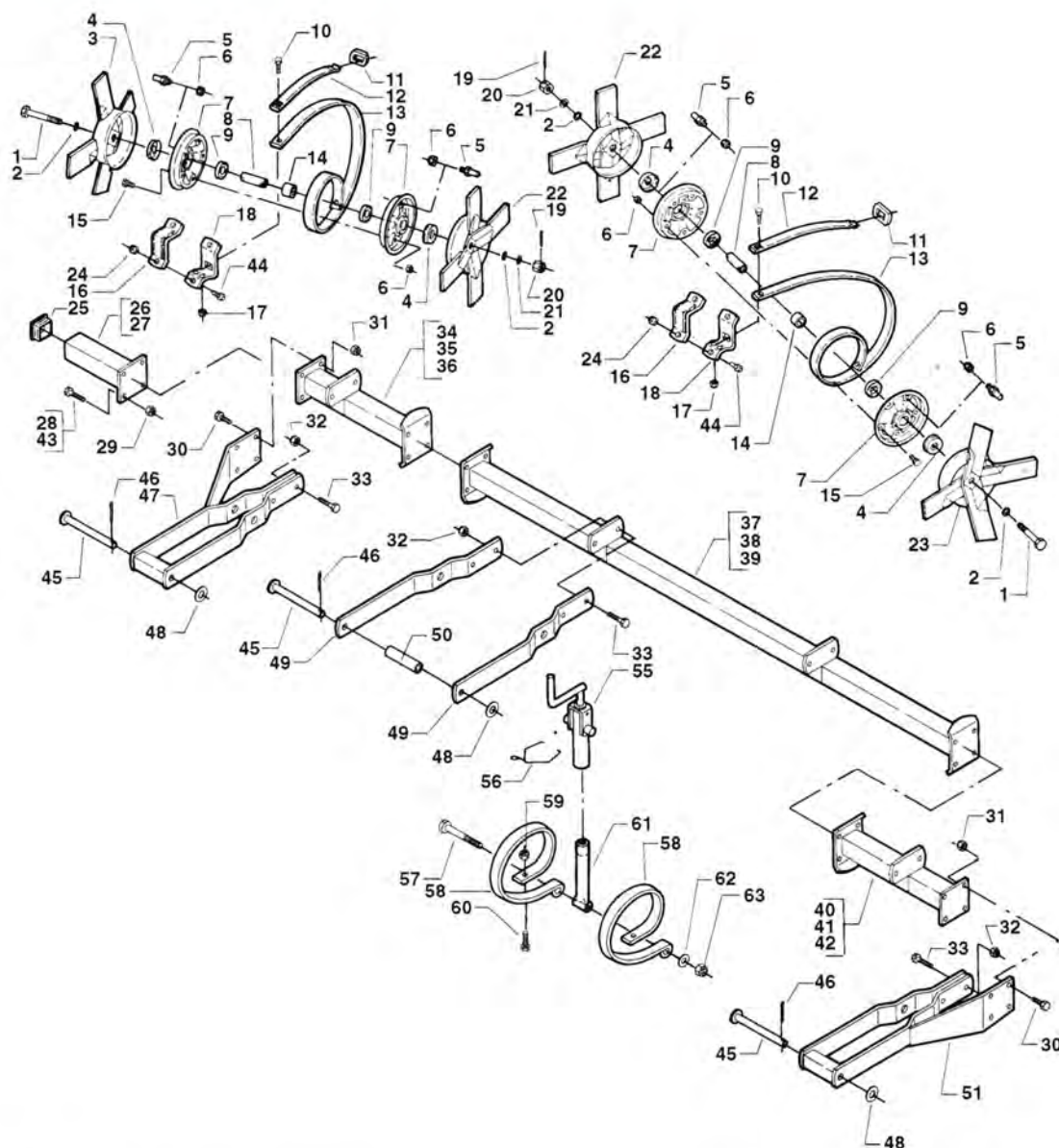

Pos.	Benævnelse	Org.	Uorg.	Model	Grp.-varenummer
3	Knivkors B med ring, højre	x		FUVF	5125-05070019
4	Lejekop for knivkors, el-galv.	x		FUVF	5125-05070033
5	Specialbolt for nav, M8, el-galv.	x		FUVF	5125-05070059
7	Navside for knivkors	x		FUVF	5125-05070030
8	Aksel for knivkors	x		FUVF	5125-05070112
9	Kugleleje m/tætning i begge sider	x			7500-6205-2RS
11	Spændebojle for fjedre	x		FUVF	5125-05070038
12	Belastningsfjeder	x		FUVF	5125-05070109
13	Fjeder for knivkors, "grisehale"	x		FUVF	5125-05070036
14	Bøsning til knivkors	x		FUVF	5125-05070111
16	Spændestykke kpl. med bolte	x		FUVF	5125-05070106
18	Spændestykke kpl. med bolte	x		FUVF	5125-05070106
22	Knivkors C med ring, lige ring (sidder altid yderst)	x		FUVF	5125-05070024
23	Knivkors A med ring, venstre	x		FUVF	5125-05070012
56	Låsefjeder	x		FUVF	5125-01000064
58	Fjeder. Beslag til do. 5125-01000507	x		FUVF	5125-04000004
*	Rep. sæt for knivkors u/lejer	x		FUVF	5125-05070086
*	Knivkors med fjeder kpl., H	x		FUFV	5125-05070119
*	Knivkors med fjeder kpl., V	x		FUFV	5125-05070118

## Diverse dele

3.010

Benævnelse	Grp.-varenummer
Maling, rød 3/4 l. M2989	5125-00205014
Spændebøsning EG, Ø12/16 x 10, DIN 1498	5125-00333040
Z-lamel Z 205/30	5125-00413073
Tætningsring 72-42-10 BZ	5125-00423027
Hjulaksel Vibroflex, for dæk 600 x 12	5125-00423035
Navkapsel med gev. 62 mm	5125-00423065
Spindel S-harve	5125-01000045
Splitbolt for hydr. løft, SBA - SGB	5125-01000063
Låsefjeder S / WB / SBA / VF	5125-01000064
Gummifjeder for stabilisator SGC	5125-01000415
Fjeder til snapkobling SGC / VF	5125-01000624
Snapkoblingssæt til påsvejsning	5125-01000747
Stabilisatorfjeder, Vibro Corn	5125-01019349
Jernendenavshjul kpl. 16" EK	5125-01020059
Gummihjul 16" EK 4-lag	5125-01020061
Udfyldningsklods, 65 mm, opstander	5125-01020073
Aksel m/lejer til 16" endenavshjul S-SG	5125-01020109
Aksel kpl. til 16" endenavshjul	5125-01020269
1 sæt jern - gaffelhjul 16" med afskraber	5125-01050000
1 sæt gummi - gaffelhjul 16" med afskrab.	5125-01050001
Skrabejernsholder	5125-01050143
Støvkapsel 52 mm til 16" hjul SGB	5125-01050189
Lejer m/afstandsrør til 16" hjul SGB, rep. sæt m/6005 leje	5125-01050191
Støvkapsel 57 mm til 18" hjul SGB	5125-01050192
Lejer m/afstandsrør til 18" hjul SGB, rep. sæt m/6205 leje	5125-01050193
Fælg m/smørenippel til dæk 500 X 8 VF	5125-01050198
Jerngaffelhjul 16" GK	5125-01050258
Jerngaffelhjul 18" GK, VF	5125-01050259
Gummigaffelhjul 16", GK	5125-01050260
Trækbom m/bøsn. & split, KAT .2 107 cm	5125-01050296
Trækbom m/split, kat. 3, 107 mm	5125-01050317
Mellemstykke, 25 x 4 - 175 mm, SGB	5125-01050327
Tætningsring, 31 x 52 x 10 mm	5125-01050336
1 sæt jerngaffelhjul 18" med afskraber	5125-01050348
Bøsning for bæreaksel/snapkobl. 38 x 28,7 x 43 mm	5125-01050588
Aksel for VF	5125-01050589
Bolt for gummistøddæmper, SGC	5125-01110031
Trækopstander SGC, 25/29 svejst	5125-01110046
Pakningssæt Germinator, cyld. Ø50 x 178 mm	5125-01200679
Låsebolt for belastningsfjeder	5125-02010032
Styr, FL, FLGB, FLVF	5125-02200013
Belastningsfjeder, samlet, REGB.	5125-03000103
Fjeder til belastningsfjeder, REGB.	5125-03000105
Lejedæksel med smørenippel t/G-leje	5125-03000396
Fjeder til slæbeplanke	5125-04000004
Fjederbeslag, SPA/SPAGB	5125-04000006
Indstillingsarm, SPA/SPAGB	5125-04000010
Splitbolt	5125-04000013
Pal, VF	5125-05000390
Afstandsbøsning, VF	5125-05000410
Pakningssæt, VF	5125-05000441
Afskraber for pakketromle, ELLIPTOR	5125-07300454



## Kulturharvetænder

3.011

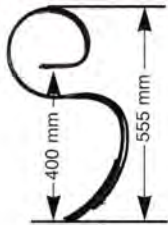

Pos. A

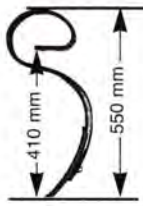

Pos. B

Pos.	Benævnelse	Original	Uoriginal	Anv. på pos.	Pk/bdt.str. eller løse	Grp.-varenummer
A	S-tand med spids, Kulti-Dan, 32 x 10	x			løs	<b>5115-0422000</b>
A	Kongskilde S-tand m/spids, 32 x 10		x		6	<b>5125-01000669</b>
A	S-tand med spids, 32 x 10		x		6	<b>5110-1013</b>
A	S-tand med spids, 32 x 12		x		6	<b>5110-1072</b>
A	S-tand uden spids, 32 x 10		x		løs	<b>5110-300001</b>
B	S-tand m/spids, spec., Combi-Dan,	x			løs	<b>5115-0422100</b>
B	Kulti-Seeder, 32 x 10 mm					
B	S-tand med spids, spec., Maxi/Master-Dan, 32 x 12 mm	x			løs	<b>5115-0422120</b>

## Spidser til kulturharvetænder



Pos. 1



Pos. 2



Pos. 3



Pos. 4



Pos. 5



Pos. 6



Pos. 7



Pos. 8

Pos.	Benævnelse	Original	Uoriginal	Anv. på pos.	Pk/bdt.str. eller løse	Grp.-varenummer
1	Spids med bolt, 6 mm, blå		x	A & B	25	<b>5120-1</b>
1	Spids med bolt, 6 mm, blå		x	A & B	25	<b>5120-10-130/625</b>
1	Spids med bolt, 8 mm, sort		x	A & B	25	<b>5120-10-130/8</b>
1	Kongskilde spids m/bolt, 6 mm, blå		x	A & B	50	<b>5125-01000640</b>
1	Kongskilde spids m/bolt, 6 mm, grøn		x	A & B	25	<b>5125-01000583</b>
2	Kongskilde spidsløser, med forskudt bolthul, 6 mm, rød		x	A & B	18	<b>5125-01000646</b>
3	Gåsefodslap, 7 cm, blå Ultra		x	A & B	25	<b>5140-10-131/6</b>
3	Kongsk. gåsefodslap, 7 cm, sort		x	A & B	50	<b>5125-01000642</b>
3	Kongsk. gåsefodslap, 7 cm, blå Ultra		x	A & B	50	<b>5125-01000650</b>
4	Renseskær u/bolt 10,5 cm, sort		x	A & B	25	<b>5140-10-132/4</b>
4	Kongsk.renneskær. med bolt, 10,5 cm, sort		x	A & B	50	<b>5125-01000644</b>
5	Renseskær u/bolt, 18 cm, 7", sort		x	A & B	25	<b>5140-10-133/5</b>
5	Renseskær u/bolt, 15 cm, 4 mm, sort		x	A & B	25	<b>5140-A30</b>
6	Kongsk. dobb.spids med bolt, sort		x	A & B	10	<b>5125-01000652</b>
7	Renseskær uden bolt, 13,5 cm, sort		x	A & B	25	<b>5120-10-143</b>
7	Kongsk.renneskær med bolt, 13,5 cm, sort		x	A & B	20	<b>5125-01019785</b>
8	Renseskær uden bolt, 20,0 cm, sort		x	A & B	25	<b>5120-10-144</b>
8	Kongsk.renneskær med bolt, 20,0 cm, sort		x	A & B	10	<b>5125-01019786</b>

## Bolt for spidser

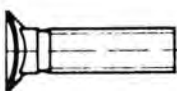
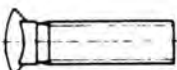

Pos.	Benævnelse	Original	Uoriginal	Anv. på pos.	Pk/bdt.str. eller løse	Grp.-varenummer
	Radrenserbolt, M10 x 37, Kv. 8.8 eller		x		100	<b>5003-1037</b>
	Radrenserbolt, M10 x 40, Kv. 8.8		x		100	<b>5003-1040</b>

## Spændestykker

3.012



Pos. 1

Pos. 2

Pos.	Benævnelse	Original	Uoriginal	Anv. på pos.	Pk/bdt.str. eller løse	Grp.-varenummer
1	Tandholder for Kulti & Combi-Dan	x		B	løs	5115-1033460
1	Tandholder for Maxi & Master-Dan	x		B	løs	5115-1033470
1	Spændestykke til 5110-1013 + 300001		x	A	25	5110-10-004
1	Spændestykke til 5110-1072		x	A	25	5110-10-006
2	Kongskilde spændestykke m/møtrik		x	A	25	5125-01000507

## Smuldreharvetænder

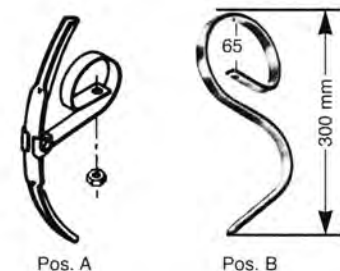

Pos. A

Pos. B

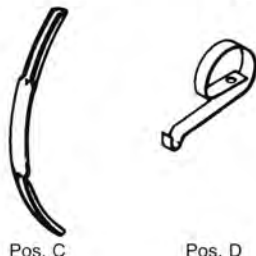

Pos. C

Pos. D

Pos.	Benævnelse	Original	Uoriginal	Anv. på pos.	Pk/bdt.str. eller løse	Grp.-varenummer
A	Tand kpl. type 90	x			løs	5115-0421500
B	Tand kpl. type 46/75		x		10	5115-1014
C	Vendbar spids type 90	x		A	10	5115-0421700
D	Overfjeder type 90	x		A	8	5115-0421600

## Spændestykker



Pos. 1

Pos. 2

Pos. 3

Pos.	Benævnelse	Original	Uoriginal	Anv. på pos.	Pk/bdt.str. eller løse	Grp.-varenummer
1	Samlingsbeslag	x		ACD	løs	5115-0421800
2	Spændestykke	x		A	løs	5115-1012800
3	Spændestykke		x	B	25	5115-10-140

## Bolte for spændestykker

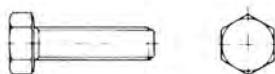

Pos.	Benævnelse	Original	Uoriginal	Anv. på pos.	Pk/bdt.str. eller løse	Grp.-varenummer
	Stålbolt M10 x 45 mm t/1012800		x		100	0222-10045
	Stålbolt M10 x 50 mm t/0421800		x		100	0222-10050
	Stålbolt M8 x 35 mm t/10-140		x		100	0222-08035



### Grubbærtænder

3.013



Pos.	Benævnelse	Original	Uoriginal	Anv. på pos.	Pk/bdt.str. eller løse	Grp.-varenummer
	Spids til Grubber-Dan	x			løs	<b>5115-1040010</b>
	Sprængbolt m/2 riller, M20 x 90 mm	x			løs	<b>5115-1040000</b>

### Bolt for spidser

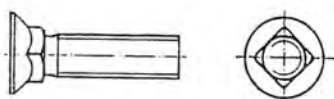

Pos.	Benævnelse	Original	Uoriginal	Anv. på pos.	Pk/bdt.str. eller løse	Grp.-varenummer
	Bolt for 5115-1040010	x			løs	<b>5000-1280</b>

### Efterharvetænder

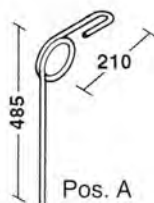

Pos.	Benævnelse	Original	Uoriginal	Anv. på pos.	Pk/bdt.str. eller løse	Grp.-varenummer
A	Langfingertand, Ø10 mm	x			løs	<b>5115-0426100</b>
A	Langfingertand, Ø12 mm	x			løs	<b>5115-0426120</b>

### Spændestykker

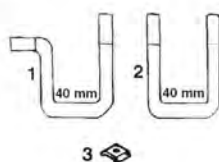

Pos.	Benævnelse	Original	Uoriginal	Anv. på pos.	Pk/bdt.str. eller løse	Grp.-varenummer
1	Spændebøjle M10, f/5115-0426100	x		A	løs	<b>5115-0382100</b>
2	Spændebøjle M12, f/5115-0426120	x		A	løs	<b>5115-0382120</b>
3	Spændeplade M10, f/5115-0426100	x		A	løs	<b>5115-1012510</b>
3	Spændeplade M12, f/5115-0426120	x		A	løs	<b>5115-1012520</b>

## Sporløsnertænder

3.014



Pos. A & B

Pos.	Benævnelse	Original	Uoriginal	Anv. på pos.	Pk/bdt.str. eller løse	Grp.-varenummer
A	Sporløsnertænder u/hjælpefjeder		x		løs	<b>5110-5012</b>
B	Hjælpefjeder t/5110-5012		x		løs	<b>5110-50120</b>

## Spidser til sporeløsnertænder



Pos. 1



Pos. 2

Pos.	Benævnelse	Original	Uoriginal	Anv. på pos.	Pk/bdt.str. eller løse	Grp.-varenummer
1	Spids med bolt, 6 mm, blå		x	A	25	<b>5120-1</b>
1	Spids med bolt, 6 mm, blå		x	A	25	<b>5120-10-130/625</b>
1	Spids med bolt, 8 mm, sort		x	A	25	<b>5120-10-130/8</b>
1	Spids med bolt, 6 mm, blå		x	A	50	<b>5125-01000640</b>
1	Spids med bolt, 6 mm, grøn		x	A	25	<b>5125-01000583</b>
2	Sporløsnertænder, 6 mm, rød, med forskudt bolthul		x	A	18	<b>5125-01000646</b>

## Bolte for spidser

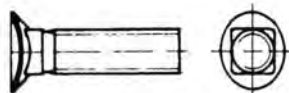

Pos.	Benævnelse	Original	Uoriginal	Anv. på pos.	Pk/bdt.str. eller løse	Grp.-varenummer
	Radrenserbolt, M10 x 37, Kv. 8.8 eller Radrenserbolt, M10 x 40, Kv. 8.8		x		100	<b>5003-1037</b>
			x		100	<b>5003-1040</b>

## Spændestykker

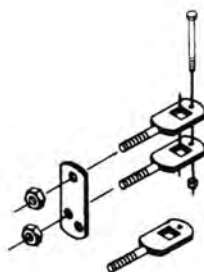

Pos.	Benævnelse	Original	Uoriginal	Anv. på pos.	Pk/bdt.str. eller løse	Grp.-varenummer
	Spændebeslag kpl. til lige firkantet tand 0424350	x			løs	<b>5115-0910200</b>



## Stubharvetænder

3.015

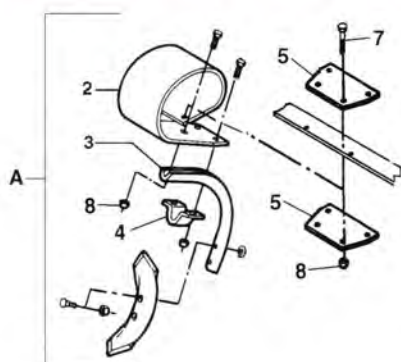

Pos.	Benævnelse	Original	Uoriginal	Anv. på pos.	Pk/bdt.str. eller løse	Grp.-varenummer
A	Kpl. stubharvetand	x			løs	<b>5115-0422701</b>
2	Overfjeder til stubharvetand	x		A	løs	<b>5115-0422711</b>
3	Undertand til stubharvetand	x		A	løs	<b>5115-0422721</b>
4	Samlestykke	x		A	løs	<b>5115-0422731</b>
5	Spændeplade	x		A	løs	<b>5115-1027070</b>
6	Spændeplade kpl. (pos. 5 - 7 - 8)	x		A	løs	<b>5115-0910231</b>
7	Stålbolt, M12 x 55 mm					<b>0210-12055</b>
8	Låsemøtrik, M12					<b>0440-12</b>

## Spidser til stubharvetænder



Pos. 1

Pos. 2



Pos. 3



Pos. 4

Pos. 5

Pos. 5a

Pos. 6



Vingskæret monteres mellem den vredne sølvspids og tanden

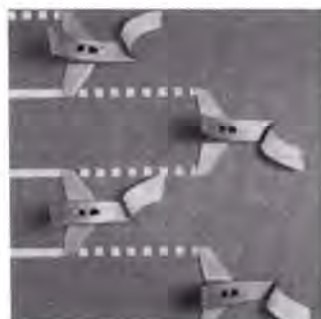

Pos. 8

Pos. 7

Pos.	Benævnelse	Original	Uoriginal	Anv. på pos.	Pk/bdt.str. eller løse	Grp.-varenummer
1	Vibroflex 2 1/2" m/bolte, 8 mm, blå		x	A	20	<b>5140-40004-820</b>
1	Vibroflex 2 1/2" u/bolte, 6 mm, sort		x	A	10	<b>5140-40-004/6</b>
1	Vibroflex 2 1/2" u/bolte, 8 mm, blå		x	A	10	<b>5140-A45</b>
1	Kongskilde 2 1/2" m/bolte, 8 mm, blå		x	A	20	<b>5125-05000504</b>
2	Vibroflex 4" m/bolte, 8 mm, blå		x	A	10	<b>5140-40005-810</b>
2	Vibroflex 4" u/bolte, 8 mm, blå		x	A	10	<b>5140-A10</b>
2	Kongskilde 4" m/bolte, 8 mm, blå		x	A	10	<b>5125-05000514</b>
2	Kongskilde 4" m/bolte, 6 mm, sort		x	A	10	<b>5125-05000485</b>
3	Kongsk.planskær 5" m/bolt, 8 mm, sort		x	A	20	<b>5125-05000486</b>
4	Kongsk.planskær 10" m/bolt, 8 mm, sort		x	A	10	<b>5125-05000487</b>
5	Solbj.syst. Vr. spids H. u/bolte, sølv		x	A	løs	<b>5140-60317</b>
5	Solbj.syst. Vr. spids H. m/bolte, sølv		x	A	10	<b>5140-60317-10</b>
5a	Solbj.syst. Vr. spids V. u/bolte, sølv		x	A	løs	<b>5140-60316</b>
5a	Solbj.syst. Vr. spids V. m/bolte, sølv		x	A	10	<b>5140-60316-10</b>
6	Solbj.syst. vingskær u/bolte 28 cm, sølv		x	A	løs	<b>5140-60239</b>
6	Solbj.syst. vingskær m/bolte 28 cm, sølv		x	A	10	<b>5140-60239-10</b>
7	"Åbningen" til tanden på vingskæret er ca. 55 mm.					
7	Stenst.syst. spids 110 mm u/bolte, blå		x	A	10	<b>5140-A15</b>
7	Stenst.syst. spids 65 mm u/bolte, blå		x	A	10	<b>5140-A16</b>
7	Stenst.syst. spids 50 mm u/bolte, blå		x	A	10	<b>5140-A17</b>
8	Stenst.syst. vingskær, 300 mm, u/bolte, blå		x	A	løs	<b>5140-A18</b>

## Spidser til stubharvetænder

3.016

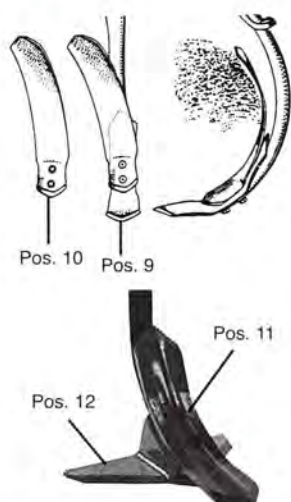

Pos.	Benævnelse	Original	Uoriginal	Anv. på pos.	Pk/bdt.str. eller løse	Grp.-varenummer
9	Stenst.syst. 2 1/2" u/bolt, blå		x	A	10	<b>5140-A45</b>
10	Stenst.syst. Non-Stop u/bolte, blå		x	A	løs	<b>5140-A46</b>
11	Kongsk. Mixing spids, 80 x 8 mm, m/bolte, blå	x		A	20	<b>5125-05000649</b>
12	Kongsk. Mix. vingskær, 260 x 6 mm, u/bolte, blå	x		A	10	<b>5125-05000650</b>

## Mega-Dan

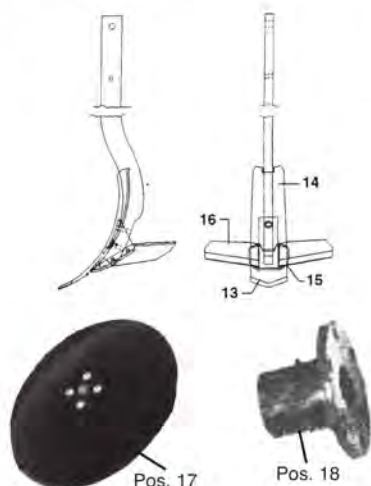

Pos.	Benævnelse	Original	Uoriginal	Anv. på pos.	Pk/bdt.str. eller løse	Grp.-varenummer
13	Skærspids m/bolt	x			løs	<b>5115-0423100</b>
14	Muldplade lige, m/bolt	x			løs	<b>5115-0423150</b>
14	Muldplade V. m/bolt	x			løs	<b>5115-0423200</b>
14	Muldplade H. m/bolt	x			løs	<b>5115-0423250</b>
15	Skærfæste m/bolt	x			løs	<b>5115-0423300</b>
16	Vingskær V. m/bolt	x			løs	<b>5115-0423400</b>
16	Vingskær H. m/bolt	x			løs	<b>5115-0423450</b>
	Sprængbolt t/ås					<b>5115-0238370</b>
17	Tallerken, Ø510 mm	x			løs	<b>5115-0428050</b>
18	Nav, Mega-Dan	x			løs	<b>5115-1066810</b>
	Sprængbolt t/tallerken					<b>5115-0235210</b>

## Bolte

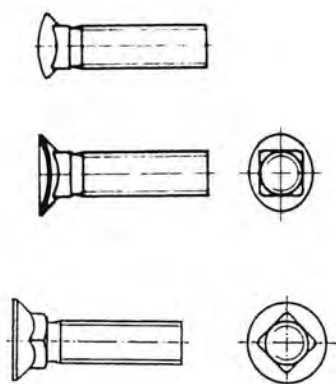

For spidser, vingskær & muldplader

Pos.	Benævnelse	Original	Uoriginal	Anv. på pos.	Pk/bdt.str. eller løse	Grp.-varenummer
	Radrenserb. m/møtrik, M12 x 48 mm		x	1 - 4	50	<b>5125-00323128</b>
	Radrenserb. M12 x 60 mm, Kv. 8.8		x	5 - 12	50	<b>5003-1260</b>
	Konisk bolt, M14 x 34 mm		x	13	100	<b>5040-013332</b>
	M14 flangemøtrik t/do		x	13	løs	<b>5008-14</b>
	Stålpløvbolt, M12 x 80 mm, 12.9	x		14	løs	<b>5000-1280</b>
	Stålpløvbolt, M12 x 55 mm, 12.9	x		15	løs	<b>5000-1256</b>
	Stålpløvbolt, M12 x 30 mm, 12.9		x	16	50	<b>5000-1230</b>
	Låsemøtrik, M12		x		100	<b>0440-12</b>



## Spændestykker

3.017

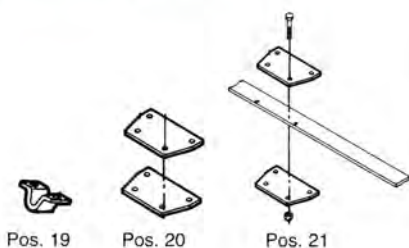

Pos.	Benævnelse	Original	Uoriginal	Anv. på pos.	Pk/bdt.str. eller løse	Grp.-varenummer
19	Samlestykke	x		A	løs	5115-0422731
20	Spændeplade	x		A	løs	5115-1027070
21	Spændebeslag kpl.	x		A	løs	5115-0910231

## Slæbeplanke

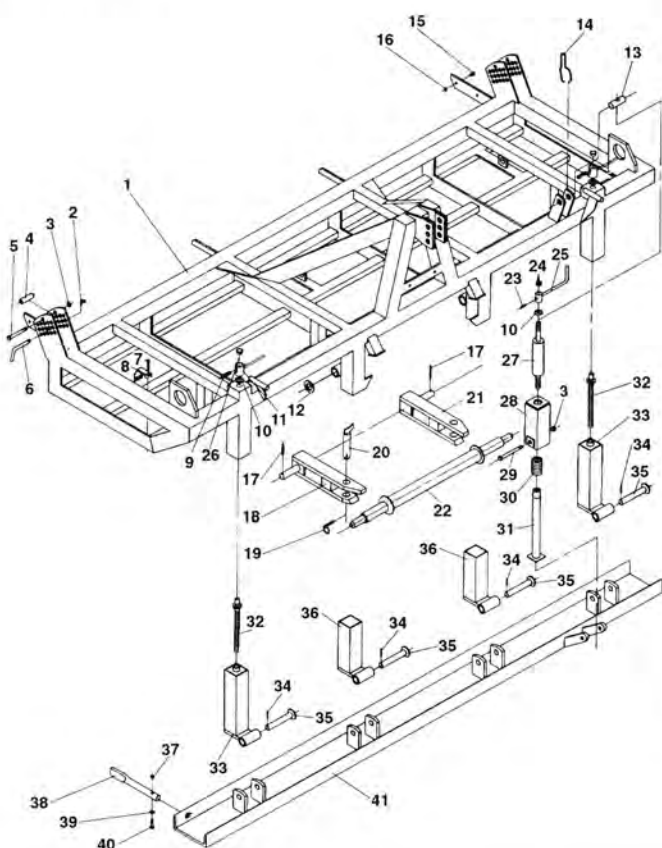

Pos.	Benævnelse	Grp.-varenummer
6	Nagle, Ø16 x 155 mm	5115-1030280
13	Leje for spindel	5115-1011470
22	Bæreaksel, Ø28 mm tappe	5115-1019950
30	Trykfjeder, Ø6 x 230 mm	5115-0431260
38	Tand Ø28 mm - se målskema	5115-1011450
39	Skråskive Ø12 mm	5115-0272720
40	Stålbolt M12 x 60 mm	0210-12060
*	Nagle 1/2" x 50 mm	5115-1011520
*	Låsepal Ø16 x 160 mm	5115-1031640
*	Sporløsnertand f/slæbeplanke	5115-1034530
	* = ikke illustreret	

### 5115-1011450 målskema

Totallængde	310 mm
Diameter	28 mm
Længde på fladt stykke	120 mm
Bredde på fladt stykke	45 mm
Kant til midthul	12 mm
Huldiameter	12 mm
Antal 3 meter	10 stk.
Antal 4 meter	14 stk.

## Pakkervalse

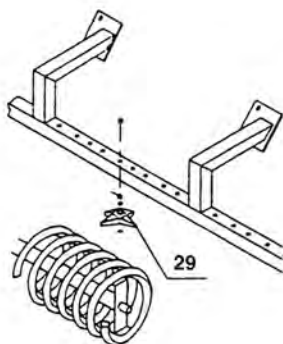

Pos.	Benævnelse	Original	Uoriginal	Anv. på pos.	Pk/bdt.str. eller løse	Grp.-varenummer
29	Stjerneafskraber til spiralvalse					5115-0510050

## Diverse dele

3.018

Benævnelse	Grp.-varenummer
Erst. af 0210-12060	<b>5115-0235400</b>
Erst. af 0210-16240	<b>5115-0242760</b>
Erst. af 0440-12	<b>5115-0264070</b>
Erst. af 0404-27	<b>5115-0262280</b>
Erst. af 1302-100045	<b>5115-0378200</b>
Erst. af 1302-152101	<b>5115-0378850</b>
Erst. af 5000-1230 + 0440-12	<b>5115-0381250</b>
Erst. af 5000-1256	<b>5115-0381300</b>
Erst. af 5000-1280	<b>5115-0381340</b>
Tætningsring	<b>5115-0391510</b>
Erst. af 7925-FI 06	<b>5115-0391520</b>
Afstandskive t/0395710	<b>5115-0391590</b>
Akselrør	<b>5115-0391600</b>
Fælg kpl. m/aksel, lejer og skiver, Kulti-Dan	<b>5115-0395710</b>
Afstandsror f/gummihjul, Kulti-Dan	<b>5115-0395720</b>
Erst. af 7925-FI 07	<b>5115-0395730</b>
Afstandsror t/0395710	<b>5115-0395740</b>
Røraksel t/gummihjul, Kulti-Dan	<b>5115-0395750</b>
Tætningsring t/gummihjul, Kulti-Dan	<b>5115-0395770</b>
Kædesamler	<b>5115-0403900</b>
Låseklods K12	<b>5115-0413300</b>
Endestykke K13	<b>5115-0413400</b>
Erst. af 5115-1014	<b>5115-0421000</b>
Erst. af 5120-1	<b>5115-0422020</b>
Erst. af 5140-40004-820 eller 5140-A45	<b>5115-0422750</b>
Erst. af 5140-40005-810 eller 5140-A10	<b>5115-0422760</b>
Erst. af 5240-0428000	<b>5115-0428000</b>
Trykfjeder, sidefløje	<b>5115-0431430</b>
Erst. af 5115-0434020	<b>5115-0434010</b>
Bladfjeder type 2 (7 x 45)	<b>5115-0434020</b>
f/rotorsmuldrer	
Fjeder f/furejævner	<b>5115-0434050</b>
Hjælpefjeder	<b>5115-0434060</b>
Pakningssæt 65/40 x 38	<b>5115-0461270</b>
Pakningssæt	<b>5115-0462070</b>
Erst. af 7000-SFTG25	<b>5115-0478500</b>
Gummipakning	<b>5115-0483500</b>
Trykring	<b>5115-0484500</b>
Nylonleje ø25 mm f/rotorsmuldrer	<b>5115-0485000</b>
Maling, 1 ltr. grøn	<b>5115-0910160G</b>
Maling, 1 ltr. rød	<b>5115-0910160R</b>
Maling, 2 1/2 ltr. grøn	<b>5115-0910170G</b>
Maling, 2 1/2 ltr. rød	<b>5115-0910170R</b>
Erst. af 5115-10-140	<b>5115-1012790</b>

Benævnelse	Grp.-varenummer
Kpl. leje	<b>5115-1011090</b>
Lejehus K15	<b>5115-1011100</b>
Lejedæksel	<b>5115-1011120</b>
Afstandsstykke K11	<b>5115-1011130</b>
Afstandsstykke	<b>5115-1011140</b>
Låseblink	<b>5115-1011150</b>
Skraber type 1, t/tallerkenharve	<b>5115-1011170</b>
Skraber type 2, t/tallerkenharve	<b>5115-1011180</b>
Lifttap	<b>5115-1011300</b>
Nagle 3/8" x 35 mm	<b>5115-1011500</b>
Nagle, Ø13 mm f/bladfjeder nr. 5115-0434020	<b>5115-1011580</b>
Spændebojle Ø14,7 mm	<b>5115-1011670</b>
t/tandpakkervalse	
Trækbom m/22 mm tappe	<b>5115-1011840</b>
Trækbom m/28 mm tappe	<b>5115-1011860</b>
Trækbom m/36 mm tappe	<b>5115-1011880</b>
Dæksel nr. 2	<b>5115-1012030</b>
Skraber f/tandpakkervalse, 70 x 210 mm	<b>5115-1021660</b>
Sideskraber f/tandpakkervalse	<b>5115-1021670</b>
Mellemlægsskive	<b>5115-1022560</b>
Aksel 1435 mm t/8 tallerkener	<b>5115-1026560</b>
Aksel 1815 mm t/10 tallerkener	<b>5115-1026580</b>
Rorbøsning	<b>5115-1033360</b>
Indv. lejeskål	<b>5115-1033370</b>
Udv. lejeskål	<b>5115-1033380</b>
Jævnertand, venstre	<b>5115-1033990</b>
Jævnertand, højre	<b>5115-1034000</b>
Sporløsertand t/slæbeplanke	<b>5115-1034530</b>
Skraberholder	<b>5115-1042270</b>



## Kulturharvetænder

3.019

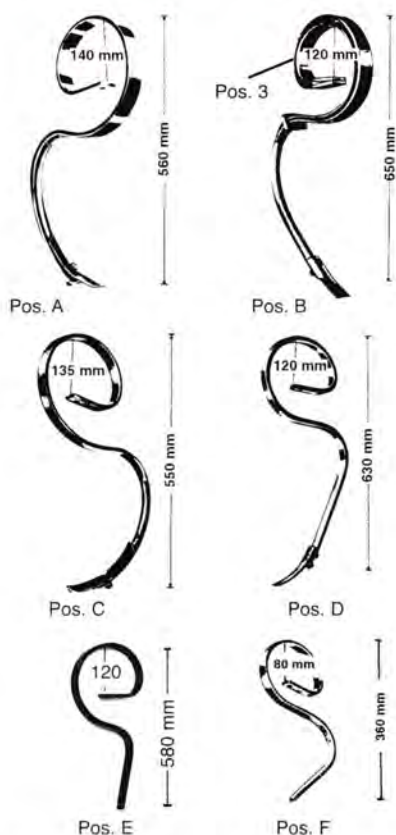

Pos.	Benævnelse	Original	Uoriginal	Anv. på pos.	Pk/bdt.str. eller løse	Grp.-varenummer
A	Kulturtand m/spids, 45 x 9 mm		x		løs	5110-J50
B	Combitand m/spids, 45 x 9 mm	x			løs	5110-J52
3	Hjælpefjeder		x		løs	5110-J52H
C	S-tand, m/spids, 32 x 10 mm		x		6	5110-1013
C	S-tand m/spids, 32 x 12 mm		x		6	5110-1072
C	S-tand u/spids, 32 x 10 mm		x		løs	5110-300001
D	Kulturtand m/spids, 32 x 12 mm		x		løs	5110-1015
E	S-tand m/spids, 32 x 12 mm		x		6	5110-1506
F	Smuldreharvetand, 25 x 8 mm		x		8	5115-1017

## Spidser til kulturharvetænder



Pos.	Benævnelse	Original	Uoriginal	Anv. på pos.	Pk/bdt.str. eller løse	Grp.-varenummer
1	Spids m/bolt, blå, 6 mm		x	A,B,C	25	5120-1
1	Spids m/bolt, blå, 6 mm		x	A,B,C	25	5120-10-130/625
1	Spids u/bolt, sort, 8 mm		x	A & C	25	5120-10-130/8
1	Spids m/bolt, blå, 6 mm		x	A,B,C	50	5125-01000640
1	Spids m/bolt, grøn, 6 mm		x	A,B,C	25	5125-01000583
1a	Sporløsnerspids m/bolt, sort		x	A,B,C	18	5125-01000646
2	Gåsefodslap, 7 cm, u/bolt, blå, ultra		x	A,B,C	25	5140-10-131/6
2	Gåsefodslap, 7 cm, m/bolt, blå, ultra		x	A,B,C	50	5125-01000650
2	Gåsefodslap, 7 cm, m/bolt, sort		x	A,B,C	50	5125-01000642
3	Renseskær u/bolt, 10,5 cm, sort		x	A,B,C	25	5140-10-132/4
3	Renseskær m/bolt, 10,5 cm, sort		x	A,B,C	50	5125-01000644
4	Renseskær u/bolt, 17,8 cm, sort		x	B	25	5140-10-133/5
4	Renseskær u/bolt, 15 cm, sort, 4 mm		x	A & C	25	5140-A30
5	Renseskær u/bolt, 13,5 cm, sort		x	A,B,C	25	5120-10-143
5	Renseskær m/bolt, 13,5 cm, sort		x	A,B,C	20	5125-01019785
6	Renseskær u/bolt, 20,0 cm, sort		x	A,B,C	25	5120-10-144
6	Renseskær m/bolt, 20,0 cm, sort		x	A,B,C	10	5125-01019786
7	M. Stig forårsspids u/bolt, blå		x	D	25	5120-10-412
7	M. Stig forårsspids u/bolt, blå		x	D	25	5130-01010063
7	M. Stig forårsspids m/bolt, blå		x	D	25	5130-01010163
8	M. Stig efterårsspids u/bolt, blå		x	D	25	5120-10-410
8	M. Stig efterårsspids u/bolt, blå		x	D	25	5130-01010062
8	M. Stig efterårsspids m/bolt, blå		x	D	25	5130-01010162

### Spidser til kulturharvetænder

3.020



Pos. 9



Pos. 10

Pos.	Benævnelse	Original	Uoriginal	Anv. på pos.	Pk/bdt.str. eller løse	Grp.-varenummer
9	M. Stig spørøsnerspids u/bolt, sølv		x	D	25	<b>5120-10-411</b>
10	Spids, lige u/bolt, sort		x	E	25	<b>5120-15-001</b>

### Bolt for spidser

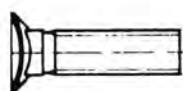

Pos.	Benævnelse	Original	Uoriginal	Anv. på pos.	Pk/bdt.str. eller løse	Grp.-varenummer
	Radrenserbolt, M10 x 37, Kv. 8.8 eller		x	ABCE	100	<b>5003-1037</b>
	Radrenserbolt, M10 x 40, Kv. 8.8		x	ABCE	100	<b>5003-1040</b>
	Stålplovbolt, 3/8" x 35 mm		x	D	100	<b>5001-1035</b>

### Spændestykker



Pos. 1



Pos.	Benævnelse	Original	Uoriginal	Anv. på pos.	Pk/bdt.str. eller løse	Grp.-varenummer
1	Spændestykke f/bulle, 50 x 12,5		x	C,D,E	25	<b>5110-10-004</b>
1	Spændestykke f/bulle, 40 x 10	x		F	25	<b>5115-10-220</b>
2	Spændestykke f/bulle, 50 x 50		x	D	25	<b>5110-10-048</b>
2	Spændestykke f/bulle, 50 x 30		x	E	25	<b>5110-10-047</b>



## Stubtænder

3.021

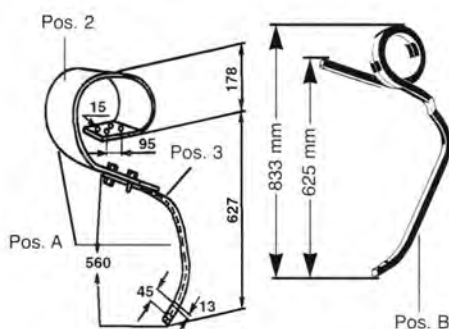

### Til Befa/Primoplex

Pos.	Benævnelse	Original	Uoriginal	Anv. på pos.	Pk/bdt.str. eller løse	Grp.-varenummer
A	Stubtand kpl. m/spids 40005-810, Model David		x		løs	5110-4047
2	Overdel t/do		x		løs	5110-40300
3	Underdel t/do, 1 hul i stilk		x		løs	5110-40218
* *	Spændes fast med U-bøjle					
B	Stubtand u/spids, 30 x 30 mm		x		løs	5110-4001

## Stubtænder

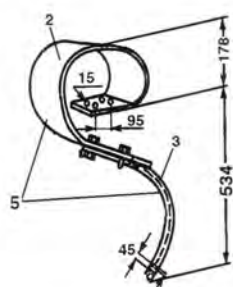

### Til Sdr. omme & Befa

Pos.	Benævnelse	Original	Uoriginal	Anv. på pos.	Pk/bdt.str. eller løse	Grp.-varenummer
5	Stubtand kpl. m/spids 40004-820, Model David		x		løs	5110-4030
2	Overdel t/do		x		løs	5110-40300
3	Underdel t/do		x		løs	5110-40301

## Spidser til stubtænder

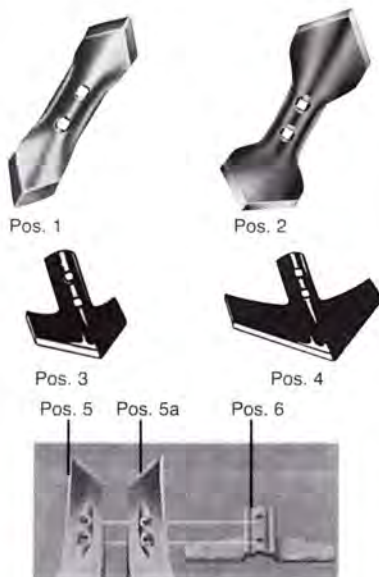

Vingskæret monteres mellem den vredne sølvspids og tanden



Pos.	Benævnelse	Original	Uoriginal	Anv. på pos.	Pk/bdt.str. eller løse	Grp.-varenummer
1	Vibroflex 2 1/2", m/bolt, 8 mm, blå		x	Alle	20	5140-40004-820
1	Vibroflex 2 1/2", u/bolt, 8 mm, blå		x	Alle	10	5140-A45
1	Vibroflex 2 1/2", m/bolt, 8 mm, blå		x	Alle	20	5125-05000504
2	Vibroflex 4", m/bolt, 8 mm, blå		x	Alle	10	5140-40005-810
2	Vibroflex 4", u/bolt, 8 mm, blå		x	Alle	10	5140-A10
2	Vibroflex 4", m/bolt, 8 mm, blå		x	Alle	10	5125-05000514
2	Vibroflex 4", m/bolt, 6 mm, sort		x	Alle	10	5125-05000485
3	Planskær 5", m/bolt, 8 mm, sort		x	Alle	20	5125-05000486
4	Planskær 10", m/bolt, 8 mm, sort		x	Alle	10	5125-05000487
5	Vr. spids H. u/bolt, Solbj.syst., sølv		x	Alle	løs	5140-60317
5	Vr. spids H. m/bolt, Solbj.syst., sølv		x	Alle	10	5140-60317-10
5a	Vr. spids V. ubolt, Solbj.syst., sølv		x	Alle	løs	5140-60316
5a	Vr. spids V. m/bolt, Solbj.syst., sølv		x	Alle	10	5140-60316-10
6	Vingskær 28 cm u/bolt, Solbj.syst., sølv		x	Alle	løs	5140-60239
6	Vingskær 28 cm m/bolt, Solbj.syst., sølv		x	Alle	10	5140-60239-10
	"Åbningen" til tanden på vingskæret er ca. 55 mm.					

## Spidser til stubtænder

3.022

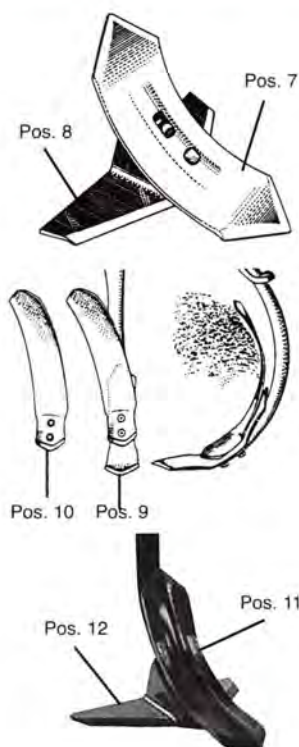

Pos.	Benævnelse	Original	Uoriginal	Anv. på pos.	Pk/bdt.str. eller løse	Grp.-varenummer
7	Stenst.syst. spids 110 mm u/bolt, blå		x	Alle	10	<b>5140-A15</b>
7	Stenst.syst. spids 65 mm u/bolt, blå		x	Alle	10	<b>5140-A16</b>
7	Stenst.syst. spids 50 mm u/bolt, blå		x	Alle	10	<b>5140-A17</b>
8	Vingesk. 30 cm u/bolt, Stenst.syst., blå		x	Alle	løs	<b>5140-A18</b>
9	Stenst.syst. spids 2 1/2" u/bolt, blå		x	Alle	10	<b>5140-A45</b>
10	Stenst.syst. Non Stop, u/bolt, blå		x	Alle	løs	<b>5140-A46</b>
11	Mix spids m/bolt Kongskilde syst. 8 mm, blå		x	Alle	20	<b>5125-05000649</b>
12	Mix vingesk. u/bolt, Kongskilde,		x	Alle	10	<b>5125-05000650</b>

## Bolt til stubspidser

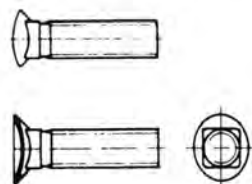

Pos.	Benævnelse	Original	Uoriginal	Anv. på pos.	Pk/bdt.str. eller løse	Grp.-varenummer
	Radrenserbolt M12 x 48 mm		x		50	<b>5125-00323128</b>

## Bolte

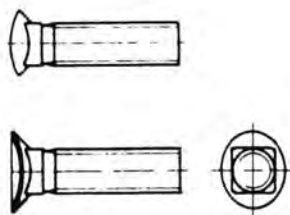

### Til vingskær, systemspidser & vredne spidser t/vingskær

Pos.	Benævnelse	Original	Uoriginal	Anv. på pos.	Pk/bdt.str. eller løse	Grp.-varenummer
	Radrenserbolt M12 x 60 mm, Kv. 8.8		x		25	<b>5003-1260</b>
	eller Radrenserbolt M12 x 70 mm, Kv. 8.8		x		25	<b>5003-1270</b>



### Kulturharvetænder

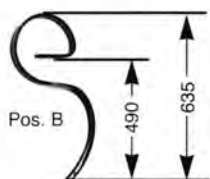

Pos. 5

Pos.	Benævnelse	Original	Uoriginal	Anv. på pos.	Pk/bdt.str. eller løse	Grp.-varenummer
B	Tand u/spids, 45 x 12, sort		x		løs	5110-1061
5	Løs overdel t/smuldreharvetand		x		løs	5115-J60A

### Spidser til diverse tænder



Pos. 1



Pos. 2



Pos. 3



Pos. 4



Pos. 5



Pos. 6



Pos. 7



Pos. 8



Pos. 9



Pos. 10

Pos.	Benævnelse	Original	Uoriginal	Anv. på pos.	Pk/bdt.str. eller løse	Grp.-varenummer
1	Spids Multiplex, u/bolt, sølv, 6 mm		x		25	5120-10-003/6
2	Spids m/bolt, blå, 6 mm		x	B	25	5120-1
2	Spids m/bolt, blå, 6 mm		x	B	25	5120-10-130/625
2	Spids m/bolt, sort, 8 mm		x	B	25	5120-10-130/8
2	Spids m/bolt, blå, 6 mm		x	B	50	5125-01000640
2	Spids m/bolt, grøn, 6 mm		x	B	25	5125-01000583
3	Sporløsnerspids m/bolt, sort, 6 mm		x	B	18	5125-01000646
4	Gåsefodsl. 7 cm, u/bolt, blå, 6 mm		x	B	25	5140-10-131/6
4	Gåsefodsl. 7 cm, m/bolt, blå, 5 mm		x	B	50	5125-01000650
4	Gåsefodsl. 7 cm, m/bolt, sort, 4 mm		x	B	50	5125-01000642
5	Rensesk. 10,5 cm, u/bolt, sort, 4 mm		x	B	25	5140-10-132/4
5	Rensesk. 10,5 cm, m/bolt, sort 3 mm		x	B	10	5125-01000644
6	Rensesk. 17,8 cm, u/bolt, sort, 5 mm		x	B	25	5140-10-133/5
6	Rensesk. 15,0 cm, u/bolt, sort, 4 mm		x	B	25	5140-A30
7	Rensesk. 13,5 cm, u/bolt, sort, 4 mm		x	B	25	5120-10-143
7	Rensesk. 13,5 cm, m/bolt, sort 3 mm		x	B	20	5125-01019785
8	Rensesk. 20 cm, u/bolt, sort, 3 mm		x	B	25	5120-10-144
8	Rensesk. 20 cm, m/bolt, sort, 3 mm		x	B	10	5125-01019786
9	Spids u/bolt, sort, 6 mm		x	B	10	5140-10-137
10	Spids m/bolt, grøn, 6 mm		x	B	25	5120-10-145/625

### Bolt for spidser

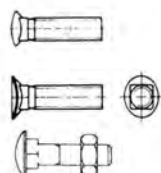

Radrenserb. M10 x 37 mm, Kv. 8.8 eller		x		100	5003-1037
Radrenserb. M10 x 40 mm, Kv. 8.8		x		100	5003-1040
Spidsbolt M8 x 25 mm, Kv. 8.8		x	1	100	5005-08025
Til Multiflex spids					

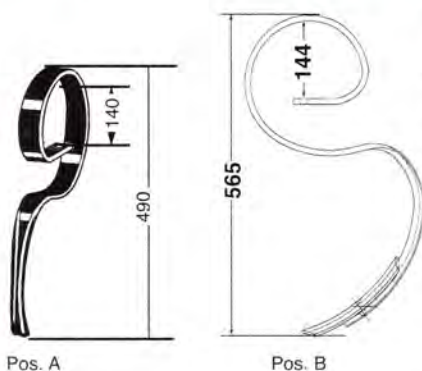

Pos.	Benævnelse	Original	Uoriginal	Anv. på pos.	Pk/bdt.str. eller løse	Grp.-varenummer
A	S-tand u/spids, 45 x 10 mm Agrilla Nova		x		løs	5110-201470
B	S-tand m/spids, 32 x 10 mm Passer også på Wiberg		x		løs	5110-400525

## Spidser til kulturharvetænder



Pos.	Benævnelse	Original	Uoriginal	Anv. på pos.	Pk/bdt.str. eller løse	Grp.-varenummer
1	Spids m/bolt, blå, 6 mm		x	A & B	25	5120-1
1	Spids m/bolt, blå, 6 mm		x	A & B	25	5120-10-130/625
1	Spids m/bolt, sort, 8 mm		x	A & B	25	5120-10-130/8
1	Spids m/bolt, blå, 6 mm		x	A & B	50	5125-01000640
1	Spids m/bolt, grøn, 6 mm		x	A & B	25	5125-01000583
2	Spids m/bolt, grøn, 6 mm		x	A & B	25	5120-10-145/625
2A	Spids u/bolt Agrilla		x	A & B	Løs	5120-302300
3	Sporløsnerspids m/bolt, sort, 6 mm		x	A & B	18	5125-01000646
4	Gåsefodslap 7 cm, u/bolt, blå, 6 mm		x	A & B	25	5140-10-131/6
4	Gåsefodslap 7 cm, m/bolt, blå, 5 mm		x	A & B	50	5125-01000650
4	Gåsefodslap 7 cm, m/bolt, sort 4 mm		x	A & B	50	5125-01000642
5	Rensesk. 10,5 cm, u/bolt, sort, 4 mm		x	A & B	25	5140-10-132/4
5	Rensesk. 10,5 cm, m/bolt, sort 3 mm		x	A & B	10	5125-01000644
6	Rensesk. 17,8 cm, u/bolt, sort, 5 mm		x	A & B	25	5140-10-133/5
6	Rensesk. 15,0 cm, u/bolt, sort, 4 mm		x	A & B	25	5140-A30
7	Rensesk. 13,5 cm, u/bolt, sort, 4 mm		x	A & B	25	5120-10-143
7	Rensesk. 13,5 cm, m/bolt, sort 3 mm		x	A & B	20	5125-01019785
8	Rensesk. 20,0 cm, u/bolt, sort, 3 mm		x	A & B	25	5120-10-144
8	Rensesk. 20 cm, m/bolt, sort, 3 mm		x	A & B	10	5125-01019786

## Bolt for spidser

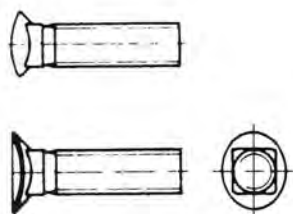

Pos.	Benævnelse	Original	Uoriginal	Anv. på pos.	Pk/bdt.str. eller løse	Grp.-varenummer
	Radrenserb. M10 x 37 mm, Kv. 8.8 eller		x		100	5003-1037
	Radrenserb. M10 x 40 mm, Kv. 8.8		x		100	5003-1040



## Spændestykker

3.025



Pos.	Benævnelse	Original	Uoriginal	Anv. på pos.	Pk/bdt.str. eller løse	Grp.-varenummer
	Spændestykke		x			5110-400528

## Efterharvetænder

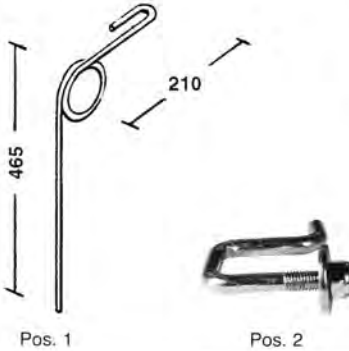

Pos.	Benævnelse	Original	Uoriginal	Anv. på pos.	Pk/bdt.str. eller løse	Grp.-varenummer
1	Efterharvetand, 9 mm		x		løs	5115-400530
1	Efterharvetand, 12 mm		x		løs	5115-400975
2	Spændestykke til begge		x		løs	5115-400976

## Stubspids

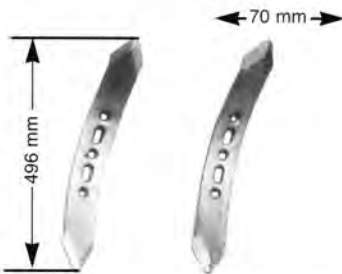

Passer på visse Viberg harver

Pos.	Benævnelse	Original	Uoriginal	Anv. på pos.	Pk/bdt.str. eller løse	Grp.-varenummer
	Stubspids, vreden, V, u/bolt, sølv		x		løs	5140-60314
	Stubspids, vreden, H, u/bolt, sølv		x		løs	5140-60315
	Stålplovbolt t/do.		x		50	5000-1260

## Tromledele



Väderstad

Pos.	Benævnelse	Original	Uoriginal	Anv. på pos.	Pk/bdt.str. eller løse	Grp.-varenummer
	Tromlering, 18", glat	x			løs	5160-301002
	Tromlering, 18", takket	x			løs	5160-301012

## Smuldreharvetænder

3.026

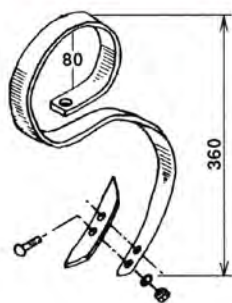

Pos.	Benævnelse	Original	Uoriginal	Anv. på pos.	Pk/bdt.str. eller løse	Grp.-varenummer
	Prela-tand m/spids, 25 x 8 mm		x		løs	<b>5115-26-22900</b>

## Smuldreharvetænder



Pos.	Benævnelse	Original	Uoriginal	Anv. på pos.	Pk/bdt.str. eller løse	Grp.-varenummer
	Prela-spids u/bolt, grøn, 5 mm		x		25	<b>5120-10-180</b>

## Bolt for spidser

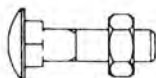

Pos.	Benævnelse	Original	Uoriginal	Anv. på pos.	Pk/bdt.str. eller løse	Grp.-varenummer
	Prela spidsbolt M8 x 25 mm, Kv. 8.8		x	1	100	<b>5005-08025</b>

## Spændestykker



Pos.	Benævnelse	Original	Uoriginal	Anv. på pos.	Pk/bdt.str. eller løse	Grp.-varenummer
	Spændestykke t/Prela-tand		x		25	<b>5115-10-220</b>



### Kulturharvetænder

3.027

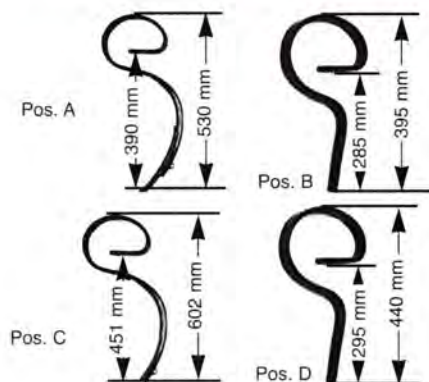

Pos.	Benævnelse	Original	Uoriginal	Anv. på pos.	Pk/bdt.str. eller løse	Grp.-varenummer
A	Harvetand m/spids, 32 x 10 mm, ny model, Dalbo, Org. 27481	x			6	5125-01000740
B	Harvetand m/spids, 32 x 10 mm	x			løs	5125-01200236
B	Harvetand m/spids, 32 x 10 mm, gl. model, Dalbo, Org. 21390		x		løs	5110-01200236
C	Harvetand u/spids, 65 x 10 mm, til JOS, Harsø, KHG m.fl.		x		løs	5110-1085
D	Harvetand m/spids, 32 x 10 mm		x		løs	5110-1504

### Spidser til kulturharvetænder



Pos.	Benævnelse	Original	Uoriginal	Anv. på pos.	Pk/bdt.str. eller løse	Grp.-varenummer
1	Spids m/bolt, blå, 6 mm			A & C	50	5125-01000640
1	Spids m/bolt, blå, 6 mm	x		A & C	25	5120-1
1	Spids m/bolt, blå, 6 mm	x		A & C	25	5120-10-130/625
1	Spids m/bolt, sort, 8 mm		x	A & C	25	5120-10-130/8
1	Spids m/bolt, grøn, 6 mm	x		A & C	25	5125-01000583
2	Sporløsnerspids m/bolt		x	A	18	5125-01000646
3	Gåsefodslap, 7 cm m/bolt, sort		x	A	50	5125-01000642
3	Gåsefodslap, 7 cm m/bolt, blå, ultra		x	A	50	5125-01000650
3	Gåsefodslap, 7 cm u/bolt, blå, ultra		x	A	25	5140-10-131/6
4	Renseskær m/bolt, 10,5 cm, sort		x	A	50	5125-01000644
4	Renseskær u/bolt, 10,5 cm, sort		x	A	25	5140-10-132/4
5	Dobb. spids m/bolt, sort		x	A	10	5125-01000652
6	Spids m/bolt, grøn, 6 mm		x	A	25	5120-10-145/625
7	Germinatorspids m/bolt, sort, 6 mm		x	B	50	5125-01200229
7	Germinatorspids m/bolt, blå, 8 mm		x	B	25	5120-A4
8	Sporløsnerspids m/bolt, sort, 6 mm		x	B	10	5125-01200231
9	Renseskær u/bolt, 18 cm, sort, 5 mm		x	A	25	5140-10-133/5
9	Renseskær u/bolt, 15 cm, sort, 4 mm		x	A	25	5140-A30
10	Spids lige u/bolt, sort, 6 mm		x	D	25	5120-15-001
11	HD spids u/bolt, sort, 6 mm		x	C	25	5140-10-137

### Bolt for spidser

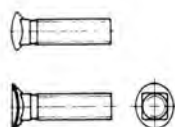

Radrenserb. M10 x 37 mm, Kv. 8.8 eller		x		100	5003-1037
Radrenserb. M10 x 40 mm, Kv. 8.8		x		100	5003-1040
Radrenserb. M10 x 70 mm, Kv. 8.8		x	C	100	5003-1070

### Spændestykker



1	Spændestykke bulle, 50 x 12 mm	x		B & D	25	5125-01000507
1	Spændestykke t/Super Q-tand	x		A	25	5125-01000742
2	Spændestykke bulle, 50 x 12 mm		x	B & D	25	5110-10-004
	Bolt for 5110-10-004, M12 x 45		x		100	0210-12045

## Dalbo - Præstbro

3.028

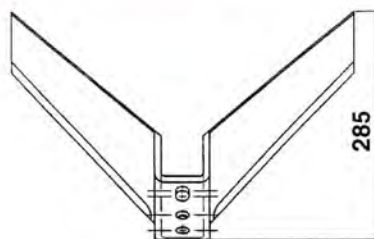

Pos.	Benævnelse	Original	Uoriginal	Anv. på pos.	Pk/bdt.str. eller løse	Grp.-varenummer
	Vingskær, Mammut. Passer på Dalbo-Dinco og på visse Præstbro, hvor vingskæret ikke er delt		x			<b>5140-60231</b>

## Præstbro

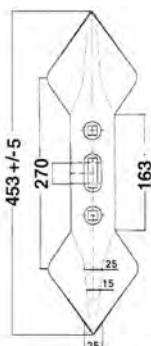

Pos.	Benævnelse	Original	Uoriginal	Anv. på pos.	Pk/bdt.str. eller løse	Grp.-varenummer
	Grubbeskær		x			<b>5140-40-066</b>

## Bolt til spidser og vingskær

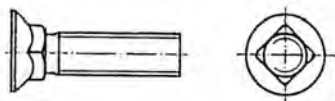

Pos.	Benævnelse	Original	Uoriginal	Anv. på pos.	Pk/bdt.str. eller løse	Grp.-varenummer
	Stålplovbolt, M12 x 60 mm, Kv. 8.8		x			<b>5000-1260</b>

Lemken Smaragd dele passer også på visse Dalbo og Præstbro halmnedmuldere.  
Se side 3.046!



## Kulturharvetænder

3.029

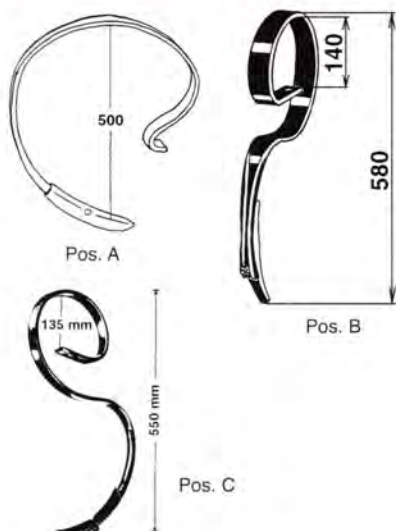

Pos.	Benævnelse	Original	Uoriginal	Anv. på pos.	Pk/bdt.str. eller løse	Grp.-varenummer
A	C-tand m/spids, rød, 32 x 10 mm	x			løs	<b>5110-103009</b>
A	* C-tand m/spids, grøn, 32 x 10 mm	x			løs	<b>5110-103012</b>
B	Strongtand m/spids 45 x 10 mm		x		4	<b>5110-300500</b>
C	Strongtand m/spids, 32 x 10 mm		x		6	<b>5110-300502</b>
C	S-tand m/spids, 32 x 10 mm		x		6	<b>5110-1013</b>
C	S-tand m/spids, 32 x 12 mm		x		6	<b>5110-1072</b>
C	S-tand u/spids, 32 x 10 mm		x		6	<b>5110-300001</b>
C	S-tand m/spids, 32 x 10 mm		x		6	<b>5125-01000669</b>

\* Den illustrerede tand er grøn model 103012. På rød model 103009 går buen, hvor spændestykket placeres, den modsatte vej.

## Spidser til kulturharvetænder



Pos.	Benævnelse	Original	Uoriginal	Anv. på pos.	Pk/bdt.str. eller løse	Grp.-varenummer
1	Spids m/bolt, grøn, 6 mm		x	A & B	25	<b>5120-10-145/625</b>
2	Spids m/bolt, blå, 6 mm		x	B & C	25	<b>5120-1</b>
2	Spids m/bolt, blå, 6 mm		x	B & C	25	<b>5120-10-130/625</b>
2	Spids m/bolt, sort, 8 mm		x	B & C	25	<b>5120-10-130/8</b>
2	Spids m/bolt, blå, 6 mm		x	B & C	50	<b>5125-01000640</b>
2	Spids m/bolt, grøn, 6 mm		x	B & C	25	<b>5125-01000583</b>
3	Sporløsnerspids m/bolt, sort, 6 mm		x	B & C	18	<b>5125-01000646</b>
4	Gåsefodslap 7 cm, u/bolt, blå, 6 mm		x	B & C	løs	<b>5140-10-131/6</b>
4	Gåsefodslap 7 cm, m/bolt, blå, 5 mm		x	B & C	50	<b>5125-01000650</b>
4	Gåsefodsl. 7 cm, m/bolt, sort, 4 mm		x	B & C	50	<b>5125-01000642</b>
5	Rensesk. 10,5 cm, u/bolt, sort, 4 mm		x	B & C	løs	<b>5140-10-132/4</b>
5	Rensesk. 10,5 cm, m/bol, sort, 3 mm		x	B & C	10	<b>5125-01000644</b>
6	Rensesk. 17,8 cm, u/bolt, sort, 5 mm		x	B & C	løs	<b>5140-10-133/5</b>
6	Rensesk. 15,0 cm, u/bolt, sort, 4 mm		x	B & C	25	<b>5140-A30</b>
7	Rensesk. 13,5 cm u/bolt, sort, 4 mm		x	B & C	25	<b>5120-10-143</b>
7	Rensesk. 13,5 cm, m/bolt, sort 3 mm		x	B & C	20	<b>5125-01019785</b>
8	Rensesk. 20 cm, u/bolt, sort, 3 mm		x	B & C	25	<b>5120-10-144</b>
8	Rensesk. 20 cm, m/bolt, sort, 3 mm		x	B & C	10	<b>5125-01019786</b>

## Bolt for spidser

3.030

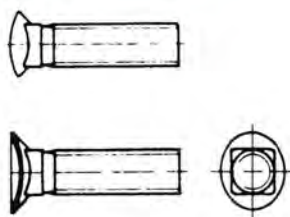

Pos.	Benævnelse	Original	Uoriginal	Anv. på pos.	Pk/bdt.str. eller løse	Grp.-varenummer
	Radrenser. M10 x 37 mm, Kv. 8.8 eller Radrenserb. M10 x 40 mm, Kv. 8.8		x		100	<b>5003-1037</b>
	Radrenserb. M10 x 45 mm, t/5110-300500		x		100	<b>5003-1040</b>
			x		100	<b>5003-1045</b>

## Spændestykker



Pos.	Benævnelse	Original	Uoriginal	Anv. på pos.	Pk/bdt.str. eller løse	Grp.-varenummer
1	Spændestk. t/C-tænder, grøn & rød	x		A	løs	<b>5110-103013</b>
2	Spændestykke (passer ikke t/5110-300502)		x	C	25	<b>5110-10-004</b>
3	Spændestykke t/5110-300500		x	B	25	<b>5110-10-059</b>
4	Spændestykke t/5110-1072		x		25	<b>5110-10-006</b>

## Styremeder til C-tandsharve

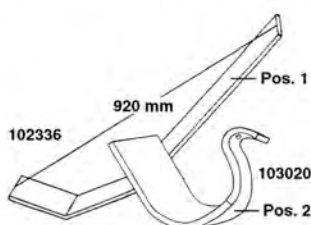

Pos.	Benævnelse	Original	Uoriginal	Anv. på pos.	Pk./bdt./str. eller løse	Grp.-varenummer
1	Styremede, ny model, lgd. 920 mm Plovbolt t/do., konisk, M12 x 40 mm		x		løs	<b>5110-102336</b>
			x		50	<b>5007-1238</b>
2	Styremede, gl. model Stålbolt t/do., M12 x 75 mm	x			løs	<b>5110-103020</b>
			x			<b>0210-12075</b>

## Efterharvetand



Pos.	Benævnelse	Original	Uoriginal	Anv. på pos.	Pk/bdt.str. eller løse	Grp.-varenummer
	Efterharvetand t/Fraugde, Ø10 mm L = 550 mm, L1 = 185 mm		x		løs	<b>5115-199280</b>
	Stålsætbolt t/do		x		100	<b>0222-12035</b>
	Efterharvet. t/Kverneland, Ø12 mm L = 530 mm, L1 = 205 mm		x		løs	<b>5115-305215</b>



## Spidser til stubtænder, Turbo II

3.031



Pos. 1

Pos. 7

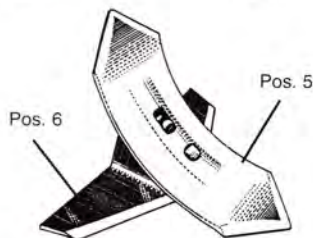

Pos. 6

Pos. 5

Pos. 2 Pos. 3 Pos. 4



Vingskæret monteres mellem den vrede sølvspids og tanden

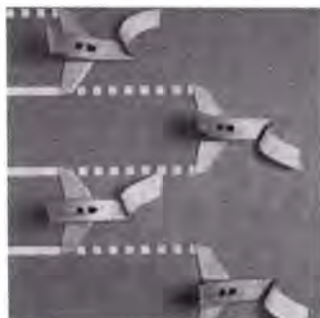

Pos.	Benævnelse	Original	Uoriginal	Anv. på pos.	Pk/bdt.str. eller løse	Grp.-varenummer
1	Universalspids, 2 1/2", 10 mm, sølv		x		10	<b>5140-40-063/10</b>
2	Solbj.syst. vr.spids H., u/bolt, sølv		x		løs	<b>5140-60317</b>
2	Solbj.syst. vr.spids H., m/bolt, sølv		x		10	<b>5140-60317-10</b>
3	Solbj.syst. vr.spids V., u/bolt, sølv		x		løs	<b>5140-60316</b>
3	Solbj.syst. vr.spids V., m/bolt, sølv		x		10	<b>5140-60316-10</b>
4	Solbj.syst., vingsk. 28 cm, u/bolt, sølv		x		løs	<b>5140-60239</b>
4	Solbj.syst., vingsk. 28 cm, m/bolt, sølv		x		10	<b>5140-60239-10</b>
5	Stenst.syst. spids, 110 mm u/bolt, blå		x		10	<b>5140-A15</b>
5	Stenst.syst. spids, 65 mm u/bolt, blå		x		10	<b>5140-A16</b>
5	Stenst.syst. spids, 50 mm u/bolt, blå		x		10	<b>5140-A17</b>
6	Stenst.syst. vingsk. 300 mm u/bolt, blå		x		løs	<b>5140-A18</b>
7	Stubspids 3 1/4" u/bolt, sølv, 8 mm, kun t/Martins & Fraugde		x		10	<b>5140-40-030/8</b>

Pos. 4, "åbningen" til tanden på vingskæret er ca. 55 mm

## Bolt for stubspidser

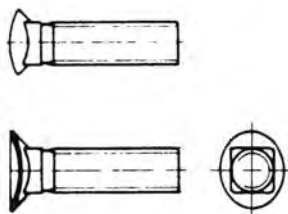

Pos.	Benævnelse	Original	Uoriginal	Anv. på pos.	Pk/bdt.str. eller løse	Grp.-varenummer
	Radrenserbolt M12 x 48 mm		x	7	50	<b>5125-00323128</b>
	Stålplovbolt		x	1		<b>5000-1250</b>

## Bolte

3.032

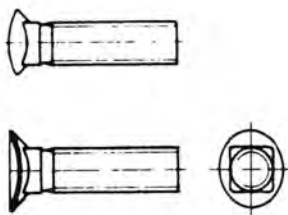

### Til vingeskær, systemspidser & vredne spidser t/vingeskær

Pos.	Benævnelse	Original	Uoriginal	Anv. på pos.	Pk/bdt.str. eller løse	Grp.-varenummer
	Radrenserbolt M12 x 60 mm, Kv. 8.8 eller Radrenserbolt M12 x 70 mm, Kv. 8.8		x		25	<b>5003-1260</b>
			x		25	<b>5003-1270</b>

## Spidser til grubbetænder

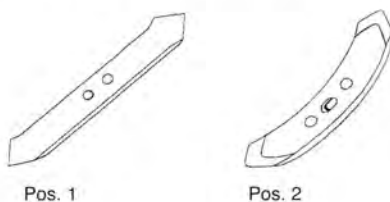

Pos.	Benævnelse	Original	Uoriginal	Anv. på pos.	Pk/bdt.str. eller løse	Grp.-varenummer
1	Grubbespids, lige m/bolte og 2 bolthuller, 420 x 20 x 60 mm Konisk bolt, M16 x 65 mm	x			løs	<b>5020-303107</b>
			x		løs	<b>5020-031965</b>
2	Konisk bolt, M16 x 75 mm Grubbespids, buet m/bolte og 3 bolthuller, 410 x 18 x 60 mm	x			løs	<b>5020-031975</b>
			x		løs	<b>5020-303110</b>
	Stålbolt, M16 x 60 mm, kv 10.9		x		50	<b>0214-16060</b>
	Stålbolt, M16 x 70 mm, kv 10.9		x		50	<b>0214-16070</b>

## Tallerkener til tallerkenharver



Pos.	Benævnelse	Original	Uoriginal	Anv. på pos.	Pk/bdt.str. eller løse	Grp.-varenummer
1	Tallerken 20", m/8 udskæringer, hulmål: 30 x 30 mm		x		løs	<b>5240-121205</b>
2	Tallerken 24", glat, hulmål: 40 x 40 mm		x		løs	<b>5240-121208</b>
1	Tallerken 24" m/9 udskæringer,		x		løs	<b>5240-121209</b>



## Kulturharvetænder

3.033

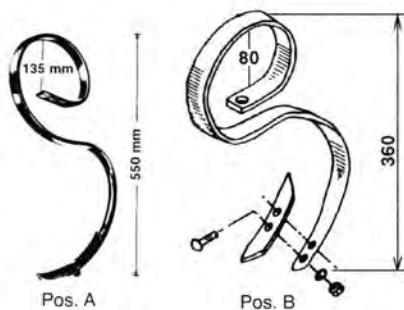

Pos.	Benævnelse	Original	Uoriginal	Anv. på pos.	Pk/bdt.str. eller løse	Grp.-varenummer
A	S-tand m/spids, 32 x 10 mm		x		6	5110-1013
A	S-tand m/spids, 32 x 12 mm		x		6	5110-1072
A	S-tand u/spids, 32 x 10 mm		x		6	5110-300001
A	S-tand m/spids, 32 x 10 mm		x		6	5125-01000669
B	Prela-tand m/spids, 25 x 8 mm, t/Combi-S harve		x	løs		5115-26-22900

## Spidser til kulturharvetænder



Pos.	Benævnelse	Original	Uoriginal	Anv. på pos.	Pk/bdt.str. eller løse	Grp.-varenummer
1	Spids m/bolt, blå, 6 mm		x	A	25	5120-1
1	Spids m/bolt, blå, 6 mm		x	A	25	5120-10-130/625
1	Spids m/bolt, sort, 8 mm		x	A	25	5120-10-130/8
1	Spids m/bolt, blå, 6 mm		x	A	50	5125-01000640
1	Spids m/bolt, grøn, 6 mm		x	A	25	5125-01000583
2	Sporløsnerspids m/bolt, sort, 6 mm		x	A	18	5125-01000646
3	Gåsefodslap 7 cm, u/bolt, blå, 6 mm		x	A	25	5140-10-131/6
3	Gåsefodslap 7 cm, m/bolt, blå, 5 mm		x	A	50	5125-01000650
3	Gåsefodslap 7 cm, m/bolt, sort 4 mm		x	A	50	5125-01000642
4	Rensesk. 10,5 cm, u/bolt, sort, 4 mm		x	A	25	5140-10-132/4
4	Rensesk. 10,5 cm, m/bolt, sort 3 mm		x	A	10	5125-01000644
5	Rensesk. 17,8 cm, u/bolt, sort, 5 mm		x	A	25	5140-10-133/5
5	Rensesk. 15,0 cm, u/bolt, sort, 4 mm		x	A	25	5140-A30
6	Rensesk. 13,5 cm, u/bolt, sort, 4 mm		x	A	25	5120-10-143
6	Rensesk. 13,5 cm, m/bolt, sort 3 mm		x	A	20	5125-01019785
7	Rensesk. 20 cm, u/bolt, sort, 3 mm		x	A	25	5120-10-144
7	Rensesk. 20 cm, m/bolt, sort, 3 mm		x	A	10	5125-01019786
8	Prela-spids, u/bolt, grøn, 5 mm		x	B	25	5120-10-180

## Bolt for spidser

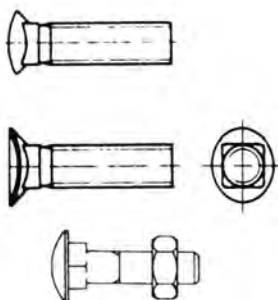

Pos.	Benævnelse	Original	Uoriginal	Anv. på pos.	Pk/bdt.str. eller løse	Grp.-varenummer
	Radrenserb. M10 x 37 mm, Kv. 8.8 eller Radrenserb. M10 x 40 mm, Kv. 8.8		x		100	5003-1037
	Spidsbolt M8 x 25 mm, Kv. 8.8 Til Multiflex spids		x		100	5003-1040
			x		100	5005-08025

## Spændestykker

3.034



Pos.	Benævnelse	Original	Uoriginal	Anv. på pos.	Pk/bdt.str. eller løse	Grp.-varenummer
1	Spændestykke t/Prela-tand		x	B	25	<b>5115-10-220</b>
2	Spændestykke		x	A	25	<b>5110-10-004</b>
3	Spændestykke t/5110-1072		x	A	25	<b>5110-10-006</b>

## Granatharvetand

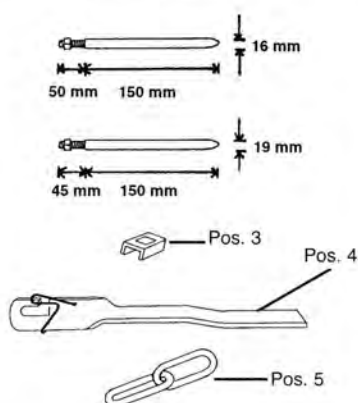

Pos.	Benævnelse	Original	Uoriginal	Anv. på pos.	Pk/bdt.str. eller løse	Grp.-varenummer
1	Granatharvetand, 16 mm, m/12 mm møtrik	x			25	<b>5150-80010026</b>
2	Granatharvetand, 19 mm, m/16 mm møtrik	x			20	<b>5150-80010027</b>
3	Tandstøtte t/16 mm tand	x			løs	<b>5150-80010028</b>
3	Tandstøtte t/19 mm tand	x			løs	<b>5150-80010029</b>
4	Trækkrog m/låsefjeder	x			løs	<b>5150-80010024</b>
4	Låsefjeder t/trækkrog	x			løs	<b>5150-80010025</b>
4	Trækkædeled	x			løs	<b>5150-80010023</b>

## Tromledele

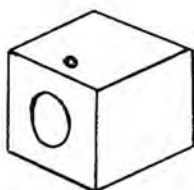

Pos.	Benævnelse	Original	Uoriginal	Anv. på pos.	Pk/bdt.str. eller løse	Grp.-varenummer
	Træbøsning t/Ø50 mm aksel	x			løs	<b>5160-90040007</b>
	Skrue m/smørenippel t/do	x			løs	<b>5160-01010011</b>



## Spidser til stubtand

3.035

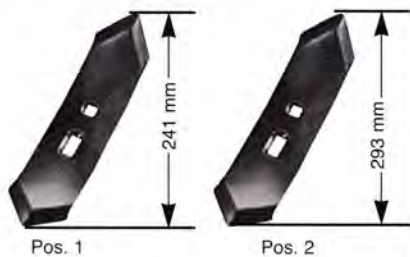

Pos.	Benævnelse	Original	Uoriginal	Anv. på pos.	Pk/bdt.str. eller løse	Grp.-varenummer
1	Universalspids 2 1/2", u/bolt, grøn, 8 mm		x		10	5140-40-060/8
2	Universalspids 2 1/2", u/bolt, sølv, 10 mm		x		10	5140-40-063/10

## Bolt for spidser

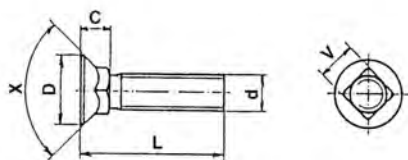

Pos.	Benævnelse	Original	Uoriginal	Anv. på pos.	Pk/bdt.str. eller løse	Grp.-varenummer
	Stålplovbolt M12 x 45 mm eller Stålplovbolt M12 x 50 mm		x		50	5000-1245
			x		50	5000-1250

## Efterharvetænder

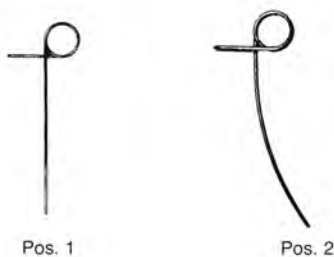

Pos.	Benævnelse	Original	Uoriginal	Anv. på pos.	Pk/bdt.str. eller løse	Grp.-varenummer
1	Efterharvetand 9,5 mm	x			løs	5130-01010076
2	Efterharvetand 12 mm	x			løs	5130-01010077

## Trækfjeder til stubharve



Pos.	Benævnelse	Original	Uoriginal	Anv. på pos.	Pk/bdt.str. eller løse	Grp.-varenummer
	Trækfjeder t/stubharve, 340 x 50 x 10 mm		x		løs	5110-1

## Kulturharvetand

3.036



Pos.	Benævnelse	Original	Uoriginal	Anv. på pos.	Pk/bdt.str. eller løse	Grp.-varenummer
	Tand kpl. 32 x 12 mm		x		løs	5110-1015

## Spidser til kulturharvetand



Pos. 1



Pos. 2



Pos. 3

1	M.Stig efterårsspids, u/bolt, blå		x		25	5120-10-410
1	M.Stig efterårsspids, u/bolt, blå		x		25	5130-01010062
1	M.Stig efterårsspids, m/bolt, blå		x		25	5130-01010162
2	M.Stig forårsspids u/bolt, blå		x		25	5120-10-412
2	M.Stig forårsspids u/bolt, blå		x		25	5130-01010063
2	M.Stig forårsspids m/bolt, blå		x		25	5130-01010163
3	Spids, rund, svær mod, ø20, sølv		x		25	5120-10-411

## Bolt for spidser

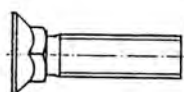

Pos.	Benævnelse	Original	Uoriginal	Anv. på pos.	Pk/bdt.str. eller løse	Grp.-varenummer
	Spidsbolt, 3/8" x 35 mm		x		100	5001-1035

## Spændestykker



Pos. 1



Pos. 2

Pos.	Benævnelse	Original	Uoriginal	Anv. på pos.	Pk/bdt.str. eller løse	Grp.-varenummer
1	Spændestykke t/bulle 50 x 12,5 mm		x		25	5110-10-004
2	Spændestykke t/bulle 50 x 50 mm		x		25	5110-10-048

## Spidser til stubtænder



Pos.	Benævnelse	Original	Uoriginal	Anv. på pos.	Pk/bdt.str. eller løse	Grp.-varenummer
	Stubspids, 3 1/2", rød, 6 mm		x		10	5140-40-085

## Bolt til stubspids

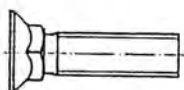

	Stålplovbolt M12 x 45 mm		x		50	5000-1245
--	--------------------------	--	---	--	----	-----------



## Sporløsnertænder

3.037

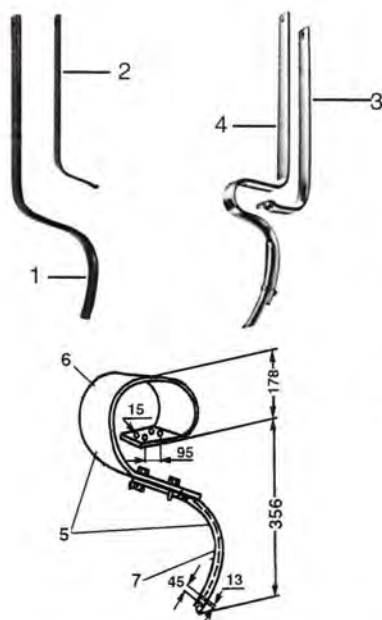

Pos.	Benævnelse	Original	Uoriginal	Anv. på pos.	Pk/bdt.str. eller løse	Grp.-varenummer
1	Sporløsnertand u/hjælpefjeder, 32 x 12 mm		x		løs	5110-5004
2	Hjælpefjeder t/do, 32 x 12 mm		x		løs	5110-50040
3	Sporløsnertand u/hjælpefjeder, 40 x 10 mm		x		løs	5110-5012
4	Hjælpefjeder t/do		x		løs	5110-50120
5	Sporløsnertand Dalbo, kpl.		x		løs	5110-4030
6	Overdel		x		løs	5110-40300
7	Underdel		x		løs	5110-40301

## Sporløsnertand

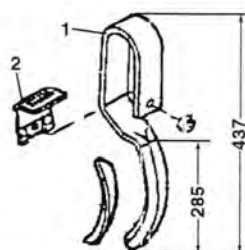

### Kongskilde Compact harve

Pos.	Benævnelse	Original	Uoriginal	Anv. på pos.	Pk/bdt.str. eller løse	Grp.-varenummer
1	Sporløsnert. m/spids, 50 x 10,8 mm	x			løs	5125-01000772
2	Spændestykke	x			løs	5125-01000769

## Spidser til sporeløsnertænder



Pos.	Benævnelse	Original	Uoriginal	Anv. på pos.	Pk/bdt.str. eller løse	Grp.-varenummer
1	Spids m/bolt, blå, 6 mm		x	1, 3	25	5120-1
1	Spids m/bolt, sølv, 6 mm		x	1, 3	25	5120-10-130/625
1	Spids u/bolt, sort, 8 mm		x	1, 3	25	5120-10-130/8
1	Spids m/bolt, blå, 6 mm		x	1, 3	50	5125-01000640
1	Spids m/bolt, grøn, 6 mm		x	1, 3	25	5125-01000583
2	Sporløsnertand m/bolt, 6 mm		x	1, 3	18	5125-01000646
3	Virboflex 2 1/2" m/bolt, sølv		x	7	20	5140-40004-820

## Bolt til spidser

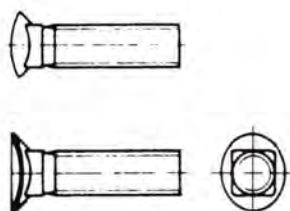

Pos.	Benævnelse	Original	Uoriginal	Anv. på pos.	Pk/bdt.str. eller løse	Grp.-varenummer
	Radrenserb. M10 x 37 mm, Kv. 8.8 eller Radrenserb. M10 x 40 mm, Kv. 8.8		x	1, 3	100	5003-1037
			x	1, 3	100	5003-1040

## Tand, let model

3.038

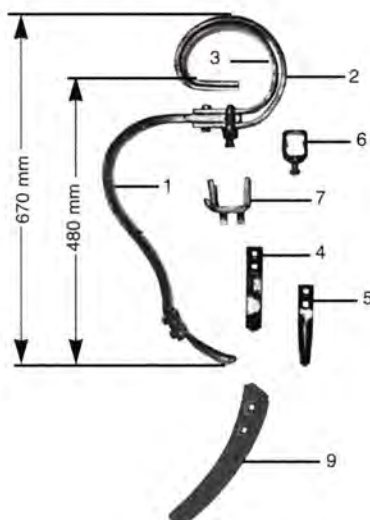

### Til model 3, før 1964, Uniflex

Pos.	Benævnelse	Original	Uoriginal	Anv. på pos.	Pk/bdt.str. eller løse	Grp.-varenummer
	Tand kpl. m/spids, 01010063	x			løs	5130-01010090
1	Undertand, løs	x			løs	5130-01010128
2	Overtand udv., løs	x			løs	5130-01010043
3	Overtand indiv., løs	x			løs	5130-01010044
4	Spids u/bolt, efterår, blå	x			25	5130-01010062
4	Spids u/bolt, efterår, blå		x		25	5120-10-410
4	Spids m/bolt, efterår, blå	x			25	5130-01010162
5	Spids u/bolt, forår, blå	x			25	5130-01010063
5	Spids u/bolt, forår, blå		x		25	5120-10-412
5	Spids m/bolt, forår, blå	x			25	5130-01010163
6	Samlestykke	x			løs	5130-01010105
7	Rammespændestykke	x			løs	5130-01010102
8	Spidsbolt, 3/8" x 35 mm		x		100	5001-1035
9	Sporløsnerspids, Ø20 mm		x		25	5120-10-411

## Tand, svær model

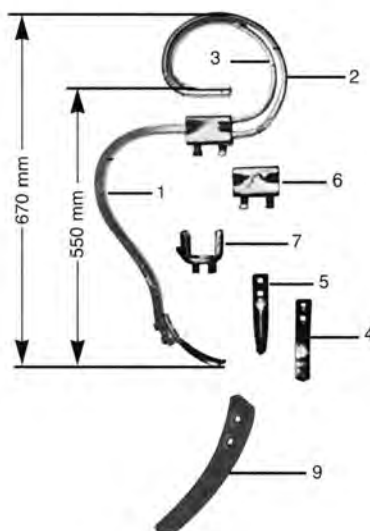

### Til model 3, 4, 8 & 9, Uniflex

Pos.	Benævnelse	Original	Uoriginal	Anv. på pos.	Pk/bdt.str. eller løse	Grp.-varenummer
	Tand kpl. m/spids, 01010063	x			løs	5130-01010087
1	Undertand, løs	x			løs	5130-01010127
2	Overtand, udv., løs	x			løs	5130-01010041
3	Overtand, indiv., løs	x			løs	5130-01010042
4	Spids u/bolt, efterår, blå	x			25	5130-01010062
4	Spids u/bolt, efterår, blå		x		25	5120-10-410
4	Spids m/bolt, efterår, blå	x			25	5130-01010162
5	Spids u/bolt, forår, blå	x			25	5130-01010063
5	Spids u/bolt, forår, blå		x		25	5120-10-412
5	Spids m/bolt, forår, blå	x			25	5130-01010163
6	Samlestykke	x			løs	5130-01010104
7	Rammespændestykke	x			løs	5130-01010101
8	Spidsbolt 3/8" x 35 mm		x		100	5001-1035
9	Sporløsnerspids, Ø20 mm		x		25	5120-10-411
	Stålskrue 5/8", t/spændest. tand/fj	x			løs	5130-90060300
	Låsestift	x			løs	5130-90060375



## Tand

3.039

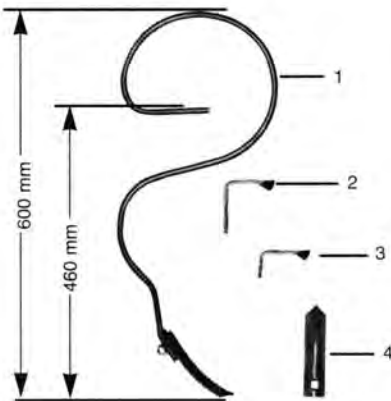

For multi Plus, MS-K model 7, Uniflex

Pos.	Benævnelse	Original	Uoriginal	Anv. på pos.	Pk/bdt.str. eller løse	Grp.-varenummer
1	Tand kpl. m/spids, 12 mm, blå					5130-01010082
1	Tand kpl. m/spids, 10 mm, blå	x				5130-01010080
2	Rammespændestykke for 50 x 50 mm bulle	x				5130-01010159
3	Rammespændestykke for 50 x 13 mm bulle	x			løs	5130-01010107
4	Spids u/bolt, blå, 5 mm	x			25	5130-01010060
	Radrenserbolt M10 x 37 mm, Kv. 8.8				100	5003-1037
	Underlagsskive	x			løs	5130-90060325
	Bolt t/spændestykke, M10 x 45 mm	x			løs	5130-90075005

## Efterharvetand



Pos. 1



Pos. 2

Pos.	Benævnelse	Original	Uoriginal	Anv. på pos.	Pk/bdt.str. eller løse	Grp.-varenummer
1	Efterharvetand, 10 mm		x		løs	5130-01010075
2	Spændestykke t/do	x			løs	5130-01010110

## Jernstøttehjul

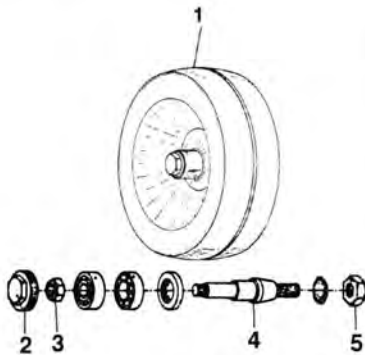

Til såbedsharver, model 3, 4 & 7

Pos.	Benævnelse	Original	Uoriginal	Anv. på pos.	Pk/bdt.str. eller løse	Grp.-varenummer
1	Jernstøttehjul m/nav & aksel	x			løs	5130-90040076
2	Navkapsel	x			løs	5130-90040131
3	M16 låsemøtrik					0440-16
4	Aksel	x			løs	5130-90040088
5	M20 låsemøtrik m/fingevind					0442-20
	Kugleleje		x		løs	7500-6205
	Kugleleje		x		løs	7500-6204
	Lameltætning		x		løs	7500-Z005

## Stubkultivator

3.040

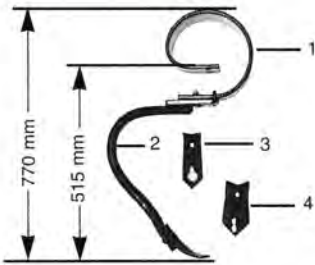

### Culti/Avanti, Uniflex

Pos.	Benævnelse	Original	Uoriginal	Anv. på pos.	Pk/bdt.str. eller løse	Grp.-varenummer
1	Tand kpl. m/spids, 01010064	x			løs	5130-01010092
	Overfjeder	x			løs	5130-01010040
2	Undertand	x			løs	5130-01010126
3	Spids u/bolt, 65 mm bred, 8 mm	x			25	5130-01010064
3	Spids m/bolt, 65 mm bred, 8 mm	x			25	5130-01010164
3	Spids u/bolt, 65 mm bred, 8 mm		x		25	5140-A9
4	Spids u/bolt, 90 mm bred, 8 mm	x			25	5130-01010065
	Radrenserbolt, M12 x 48 mm, til spidser		x		50	5125-00323128
	Stålbolt, M16 x 50 mm, til montering på bulle		x		50	0222-16050
	M16 låsemøtrik	x			løs	0440-16
	Stålbolt, M12 x 45 mm, til samling af tand				løs	5130-90075008
	Underlagsskive t/spidser	x			løs	5130-90060326

## Lamelslæbeplanke

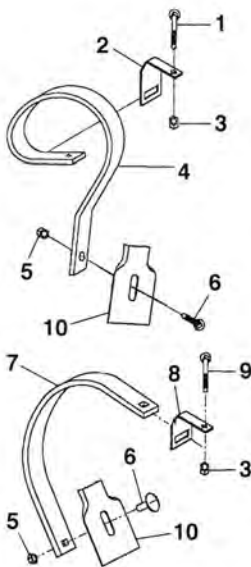

### Concord

Pos.	Benævnelse	Original	Uoriginal	Anv. på pos.	Pk/bdt.str. eller løse	Grp.-varenummer
1	Stålbolt, M10 x 80 mm - 90060035		x		50	0210-10080
2	Spændestykke f/bulle 50 x 50	x			løs	5130-01010177
3	Låsemøtrik, M10		x		100	0440-10
4	Tand 10 mm	x			løs	5130-00719901
5	Låsemøtrik, M12		x		100	0440-12
6	Brædebolt, M12 x 35 mm, kval. 8.8	x			Løs	5130-90060026
7	Fjederbøjle	x			Løs	5130-34010020
8	Spændestykke f/bulle 50 x 30 mm	x			Løs	5130-01010161
9	Stålbolt M10 x 60 mm		x		50	0210-10060
10	Afskraberblad	x			Løs	5130-34010021

## Rotorsmuldrer

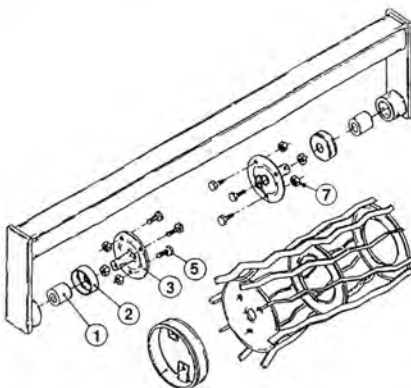

Pos.	Benævnelse	Original	Uoriginal	Anv. på pos.	Pk/bdt.str. eller løse	Grp.-varenummer
1	Nylonbøsning	x			løs	5130-87010000
2	Støvkapsel	x			løs	5130-87010001
3	Flange med akse	x			løs	5130-87010002
5	Stålsætbolt, M10 x 30		x		100	0222-10030
7	Møtrik M10		x		100	0404-10



## Grubber

3.041

Ill. viser højre

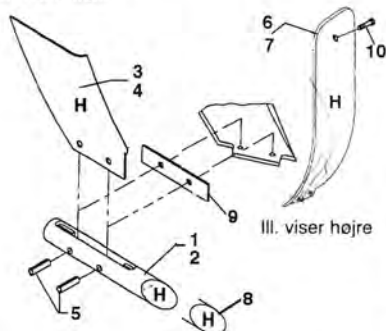

### Ratoon System 1996

Pos.	Benævnelse	Original	Uoriginal	Anv. på pos.	Pk/bdt.str. eller løse	Grp.-varenummer
1	Ratoon-spids, V. model 1996, Ø60 mm	x			løs	5130-49010107
2	Ratoon-spids, H. model 1996, Ø60 mm	x			løs	5130-49010106
3	Muldplade for spids, højre	x			løs	5130-49010024
4	Muldplade for spids, venstre	x			løs	5130-49010025
5	Hulspændestift, M16 x 60 mm		x		10	1113-160060
6	Tand, venstre	x			løs	5130-49010001
7	Tand, højre	x			løs	5130-49010002
8	Slidspids t/påsevsning	x			løs	5130-49010108
9	Mellemlægsplade for spids	x			løs	5130-49010023
10	Springbolt M16 x 65 mm, kv. 10.9	x			løs	5130-90060095

## Grubber

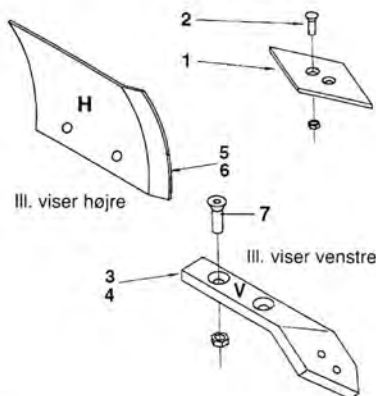

### Ratoon System 1995

Pos.	Benævnelse	Original	Uoriginal	Anv. på pos.	Pk/bdt.str. eller løse	Grp.-varenummer
1	Ratoon, Vb. spids	x			løs	5130-49010010
2	Stålplovbolt, M10 x 45 mm		x		100	5000-1045
3	Spidsholder, venstre	x			løs	5130-49010011
4	Spidsholder, højre	x			løs	5130-49010012
5	Beskyttelsesplade, venstre	x			løs	5130-49010013
6	Beskyttelsesplade, højre	x			løs	5130-49010014
7	Bolt m/indv. 6-kant, US		x		50	0316-16060

## Tand

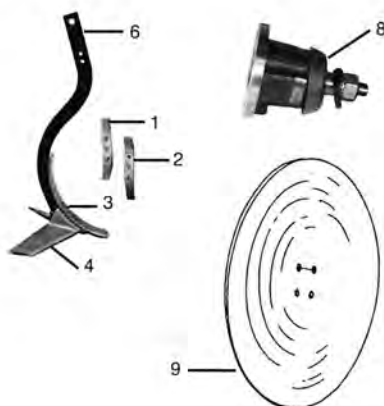

### Til Garant halmnedmulder

Pos.	Benævnelse	Original	Uoriginal	Anv. på pos.	Pk/bdt.str. eller løse	Grp.-varenummer
1	Grubbeskær, venstre, 70 mm	x			løs	5130-01010131
2	Grubbeskær, højre, 70 mm	x			løs	5130-01010130
3	Grubbeskær, lige, 70 mm	x			løs	5130-01010100
4	Vingskær, 430 mm	x			løs	5130-01010099
5	Stålplovbolt, M12 x 70 mm, til vingskær		x		50	5000-1270
6	Tand u/skær	x			løs	5130-01010098
	Springbolt m/låsemøtrik, M12 x 75 mm, KV. 10.9	x			løs	5130-90075035
8	Nav t/tallerken	x			løs	5130-90040207
9	Tallerken, 450 mm	x			løs	5130-42010015

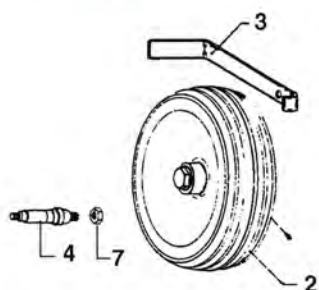

### Til stubharve

Pos.	Benævnelse	Original	Uoriginal	Anv. på pos.	Pk/bdt.str. eller løse	Grp.-varenummer
2	Hjul kpl. m/støtte & skraber	x			løs	5130-01010146
	Hjul m/aksel, 145 x 460 mm	x			løs	5130-90040078
3	Skraber, højre & venstre	x			løs	5130-01010147
4	Aksel	x			løs	5130-90040080
6	Navkapsel	x			løs	5130-90040128
7	Låsemøtrik, M20 x 1,5		x		løs	0442-20

## Granatharvetand

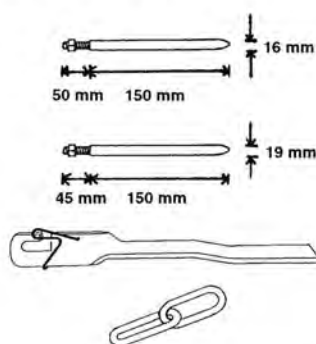

Pos.	Benævnelse	Original	Uoriginal	Anv. på pos.	Pk/bdt.str. eller løse	Grp.-varenummer
	Granatharvetand, 16 mm, m/12 mm møtrik	x			25	5150-80010026
	Granatharvetand, 19 mm, m/16 mm møtrik	x			20	5150-80010027
	Trækkrog m/låsefjeder	x			løs	5150-80010024
	Låsefjeder t/trækkrog	x			løs	5150-80010025
	Trækkædeled	x			løs	5150-80010023

## Tromledele

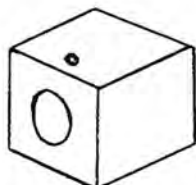

Pos.	Benævnelse	Original	Uoriginal	Anv. på pos.	Pk/bdt.str. eller løse	Grp.-varenummer
	Træbøsning til Ø50 mm aksel	x			løs	5160-90040007
	Skrue med smørenippel t/do	x			løs	5160-01010011

## Efterharvetænder

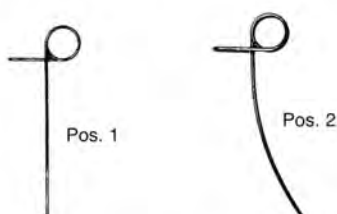

Pos.	Benævnelse	Original	Uoriginal	Anv. på pos.	Pk/bdt.str. eller løse	Grp.-varenummer
1	Efterharvetand 9,5 mm	x			løs	5130-01010076
2	Efterharvetand 12 mm	x			løs	5130-01010077

## Trækfjeder til stubharve



Pos.	Benævnelse	Original	Uoriginal	Anv. på pos.	Pk/bdt.str. eller løse	Grp.-varenummer
	Trækfjeder til stubharve, 340 x 50 x 10 mm		x		løs	5110-1



## Kulturharvetænder

3.043

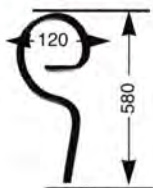

### Til kombiharver

Pos.	Benævnelse	Original	Uoriginal	Anv. på pos.	Pk/bdt.str. eller løse	Grp.-varenummer
	S-tand, lige kpl. 32 x 12 mm		x		løs	5110-1506

## Spidser til kulturharvetand



Pos.	Benævnelse	Original	Uoriginal	Anv. på pos.	Pk/bdt.str. eller løse	Grp.-varenummer
	Spids, lige, 6 mm, sort		x	1	25	5120-15-001

## Spændestykker



Pos.	Benævnelse	Original	Uoriginal	Anv. på pos.	Pk/bdt.str. eller løse	Grp.-varenummer
	Spændestykke		x	1	25	5110-10-047

## Bolt til spidser

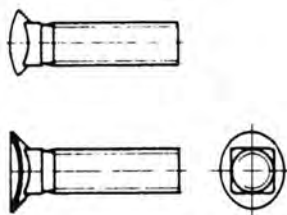

Pos.	Benævnelse	Original	Uoriginal	Anv. på pos.	Pk/bdt.str. eller løse	Grp.-varenummer
	Radrenserb. M10 x 40 mm, Kv. 8.8		x	1	100	5003-1040

## Sporløsnertand

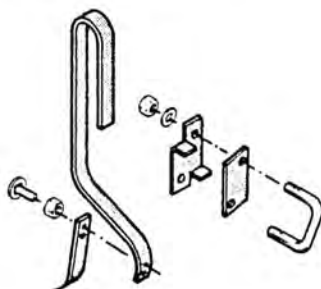

Pos.	Benævnelse	Original	Uoriginal	Anv. på pos.	Pk/bdt.str. eller løse	Grp.-varenummer
	Sporløsnert., passer på Combisæt					6050-84431000

## Stubharvetænder

3.044

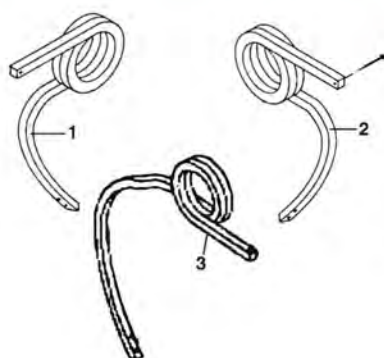

### Bulldog

Pos.	Benævnelse	Original	Uoriginal	Anv. på pos.	Pk/bdt.str. eller løse	Grp.-varenummer
1	Tand, forr. venstre u/spids	x			løs	5132-100551
2	Tand, forr. højre u/spids	x			løs	5132-100553
3	Stubtand - Vaks 1)	x			løs	5132-1005159

1) Erstatte 10552 og 100554

Vingskær kan ikke anvendes på ovennævnte tænder!

## Spidser for stubharvetænder

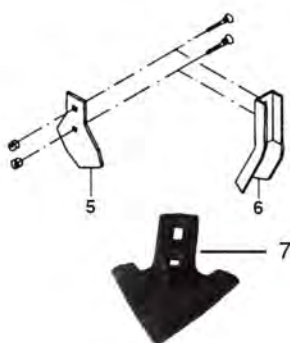

Pos.	Benævnelse	Original	Uoriginal	Anv. på pos.	Pk/bdt.str. eller løse	Grp.-varenummer
5	Tidselspids, 4 1/2", u/bolte (passer på alle Agrodan- & Dalsø-tænder)		x		10	5132-100563
6	Stubspids 3", u/bolte (passer på alle Agrodan- & Dalsø-tænder undtagen 32 x 32 mm Bulldog-tænder)		x		10	5132-100599
7	Spids, 200 mm, u/bolte	x			10	5132-100562
7	Spids, 250 mm, u/bolte	x			10	5132-100572
7	Spids, 300 mm, u/bolte	x			10	5132-100561
	(kan anvendes på Agrodan & Dalsø-tænder, når nederste bolt monteres først, og øverste spændes let på tanden)					

## Bolte for spidser

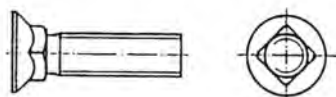

Pos.	Benævnelse	Original	Uoriginal	Anv. på pos.	Pk/bdt.str. eller løse	Grp.-varenummer
	Stålplovbolt, M12 x 45 mm, KV 12.9		x		50	5000-1245

## Spændestykker

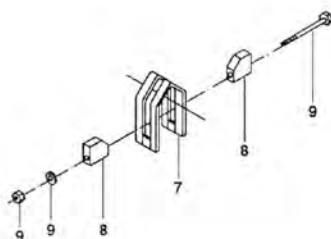

Pos.	Benævnelse	Original	Uoriginal	Anv. på pos.	Pk/bdt.str. eller løse	Grp.-varenummer
7	Spændebøjle	x			løs	5132-100534
8	Spændeklods	x			løs	5132-100535
9	Stålbolt, M16 x 140 mm		x		50	0210-16140
9	Stålmøtrik M16		x		100	0404-16
9	Skive M16		x		100	0502-16



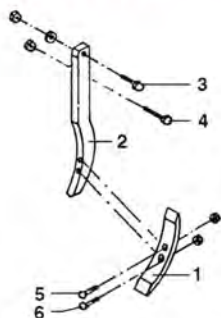

Pos.	Benævnelse	Original	Uoriginal	Anv. på pos.	Pk/bdt.str. eller løse	Grp.-varenummer
1	Mejselskær, svær, 460 x 25 x 60 mm	x			løs	<b>5132-100565</b>
2	Grubberstilk f/100565	x			løs	<b>5132-100569</b>
3	Monteringsbolt	x			løs	<b>5132-507077</b>
4	Sikringsbolt	x			løs	<b>5132-100026</b>
5	Stålplovbolt, M16 x 80 mm		x		25	<b>5000-1680</b>
6	Stålplovbolt, M16 x 90 mm		x		25	<b>5000-1690</b>

## Lemken-Smaragd, Howard-Delta m.fl.

3.046

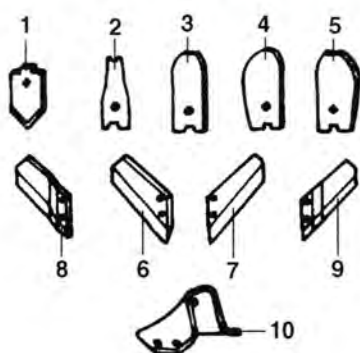

Pos.	Benævnelse	Original	Uoriginal	Anv. på pos.	Pk/bdt.str. eller løse	Grp.-varenummer
1	Grubbespids, 10 mm		x		løs	5140-3374388
1	Grubbespids, 12 mm, hårdbelagt		x		løs	5140-3374392
2	Muldplade, center, smal		x		løs	5140-3374394
3	Muldplade, center		x		løs	5140-3374395
4	Muldplade, højre		x		løs	5140-3374398
5	Muldplade, venstre		x		løs	5140-3374399
6	Vingskær, højre, 10 mm		x		løs	5140-3374416
7	Vingskær, venstre, 10 mm		x		løs	5140-3374417
8	Vingskær forkr., højre, 11 mm		x		løs	5140-3374420
8	Vingskær, forkr., højre, hårdbelagt		x		løs	5140-3374424
9	Vingskær forkr., venstre 11 mm		x		løs	5140-3374421
9	Vingskær, forkr., venstre, hårdbel.		x		løs	5140-3374425
10	Holder t/slidlele		x		løs	5140-4679105
	Sprængbolt f/tand, Smaragd 80		x		løs	0214-10070
	Sprængbolt f/tand, Smaragd 90		x		løs	0214-12070
	Bolt t/spids, M12 x 30 mm, Kv. 12.9		x		50	5000-1230
	Bolt t/muldplade, M12 x 60 mm, Kv. 8.8		x		50	5000-1260
	Bolt t/vingskær, M12 x 30 mm, Kv. 10.9		x		løs	5008-1230
	Alle dele er incl. bolte					

## Lemken, Kompaktor



Pos.	Benævnelse	Original	Uoriginal	Anv. på pos.	Pk/bdt.str. eller løse	Grp.-varenummer
	Gåsefodsskær, blå, incl. bolt		x		løs	5140-3374356

## Rabe



Pos.	Benævnelse	Original	Uoriginal	Anv. på pos.	Pk/bdt.str. eller løse	Grp.-varenummer
	Vingskær, højre		x		løs	5140-GG45
	Vingskær, venstre		x		løs	5140-GG45L

## Bovlund

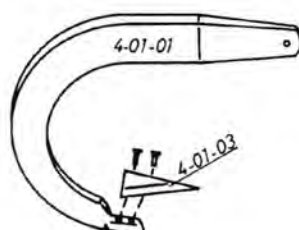

### Til montering på plov

Pos.	Benævnelse	Original	Uoriginal	Anv. på pos.	Pk/bdt.str. eller løse	Grp.-varenummer
	Spids u/bolt				løs	5010-40103
	Stålplovbolt, 7/16" x 50 mm				50	5001-1150



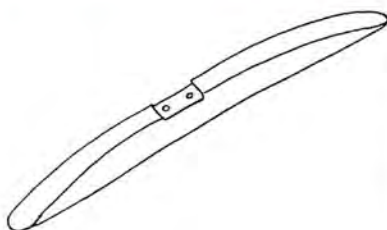

Type 70 & 100

Pos.	Benævnelse	Original	Uoriginal	Anv. på pos.	Pk/bdt.str. eller løse	Grp.-varenummer
	Vendbar spids u/bolte				løs	<b>5010-40151</b>
	Stålbolt, M16 x 100 mm Møtrik M16 Bemærk! Boltene skal slås i bund i spidsen				25 50	<b>0210-16100</b> <b>0404-16</b>

### Bovlund, undergrundslosner



Pos.	Benævnelse	Original	Uoriginal	Anv. på pos.	Pk/bdt.str. eller løse	Grp.-varenummer
	Vendb. spids u/bolt, 500 x 10 x 88 mm, 30 mm amlæg på tand				løs	<b>5010-40141</b>
	Stålplovbolt, 5/8" UNF x 70 mm				25	<b>5001-1670</b>
	Stålplovbolt, 5/8" UNF x 80 mm				25	<b>5001-1680</b>

### Solbjerg grubberdele

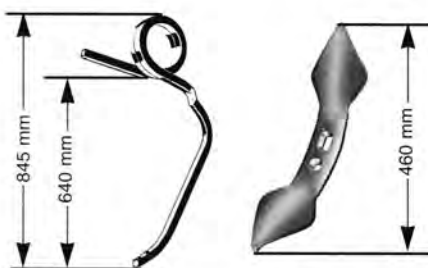

Pos. 1

Pos. 2

Pos.	Benævnelse	Original	Uoriginal	Anv. på pos.	Pk/bdt.str. eller løse	Grp.-varenummer
1	Grubbetand u/spids, 30 x 30 mm		x		løs	<b>5110-4001</b>
2	Hjertesker 5" u/bolt, 16 mm, sort 1)		x		5	<b>5140-40-019</b>
3	Vr.spids, venstre, m/bolt, sølv		x		10	<b>5140-60316-10</b>
4	Vr.spids, højre, m/bolt, sølv		x		10	<b>5140-60317-10</b>
5	Univ.spids, 2 1/2" u/bolt, 8 mm, grøn		x		10	<b>5140-40-060/8</b>
6	Univ.spids, 2 1/2" u/bolt, 10 mm, sølv		x		10	<b>5140-40-063/10</b>



Pos. 3

Pos. 4



Pos. 5

Pos. 6

1) Anvendes bl.a. på Becker og Egebak grubber.

### Bolt for spidser

3.048

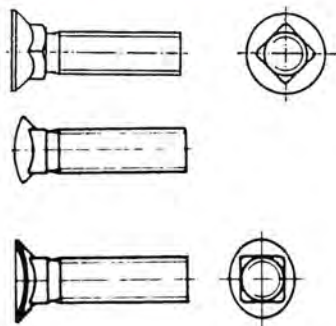

Til 40-060/8 og 40-063/10  
Til vreden spids og hjerteskar

Pos.	Benævnelse	Original	Uoriginal	Anv. på pos.	Pk/bdt.str. eller løse	Grp.-varenummer
	Stålplovbolt, M12 x 60 mm		x	2	50	<b>5000-1260</b>
	Radrenserb., M12 x 60 mm, Kv. 8.8 eller		x	3 & 4	25	<b>5003-1260</b>
	Radrenserb., M12 x 70 mm, Kv. 8.8		x	3 & 4	25	<b>5003-1270</b>
	Stålplovbolt, M12 x 50 mm		x	5 & 6	50	<b>5000-1250</b>



## Amazone

3.049

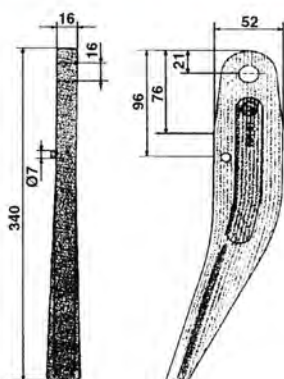

Model KG 40

Pos.	Benævnelse	Original	Uoriginal	Anv. på pos.	Pk/bdt.str. eller løse	Grp.-varenummer
	Rotorharvetand, højre & venstre		x		løs	5121-61223

## Amazone

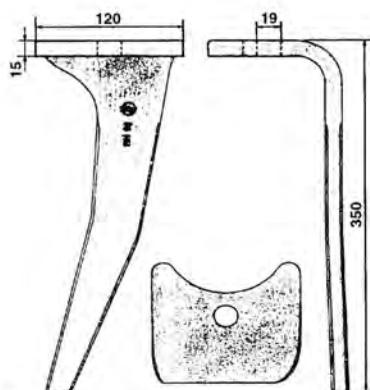

Illustrationen viser venstre model

Model KG 301 & KG 401

Pos.	Benævnelse	Original	Uoriginal	Anv. på pos.	Pk/bdt.str. eller løse	Grp.-varenummer
	Rotorharvetand, højre		x		løs	5121-61473
	Rotorharvetand, venstre		x		løs	5121-61483
	Bolt m/split, M16 x 70 mm - Ø24 mm		x		løs	5121-167024

## Amazone

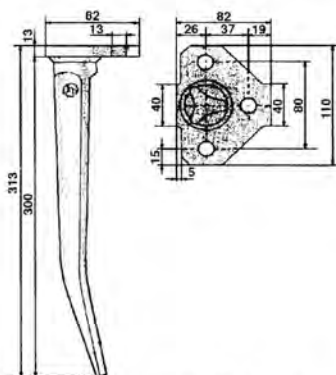

Illustrationen viser 63021, bag.

Pendulharve

Pos.	Benævnelse	Original	Uoriginal	Anv. på pos.	Pk/bdt.str. eller løse	Grp.-varenummer
	Pendulharvetand, bag.		x		løs	5121-63021
	Pendulharvetand, forr.		x		løs	5121-63031

## Amazone

3.050

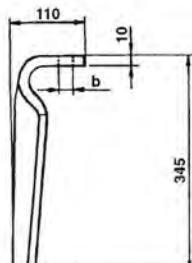
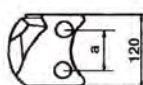

Højre model:  
A = 75 mm  
B = 17 mm

Venstre model:  
A = 81 mm  
B = 18,5 mm

Illustrationen viser højre model

### Model KE

Pos.	Benævnelse	Original	Uoriginal	Anv. på pos.	Pk/bdt.str. eller løse	Grp.-varenummer
	Rotorharvetand, højre		x		løs	<b>5121-6802400</b>
	Rotorharvetand, venstre		x		løs	<b>5121-6804400</b>
	Bolt t/do, M16 x 1,5 x 45 mm		x		løs	<b>5121-1645</b>
	Låsemøtrik m/krave M16		x		løs	<b>5121-80201662</b>

Længde meter	Antal tænder højre	Antal tænder venstre
2,5	8	8
3,0	10	10
4,0	14	14

## Amazone

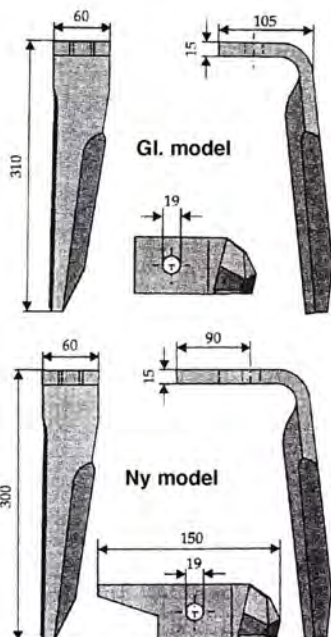

### Model KE 302/303

Pos.	Benævnelse	Original	Uoriginal	Anv. på pos.	Pk/bdt.str. eller løse	Grp.-varenummer
	Gl. model: Rotorharvetand, højre		x		løs	<b>5121-691951011</b>
	Rotorharvetand, venstre		x		løs	<b>5121-691951012</b>
	Ny model: Rotorharvetand, højre med hak		x		løs	<b>5121-691951013</b>
	Rotorharvetand, venstre med hak		x		løs	<b>5121-691951014</b>

## Afstrygere

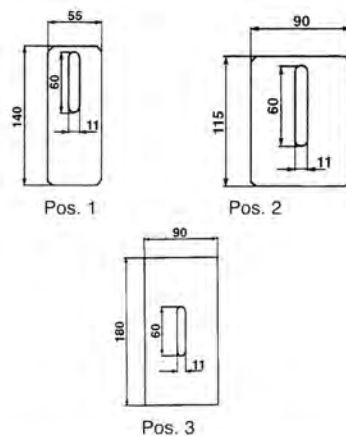

### Til Amazone pakkevalser

Pos.	Benævnelse	Original	Uoriginal	Anv. på pos.	Pk/bdt.str. eller løse	Grp.-varenummer
1	Afstryger, 140 x 55 mm		x		løs	<b>5121-60362</b>
2	Afstryger, 115 x 90 mm		x		løs	<b>5121-60812</b>
3	Plastafstryger, 90 x 180 mm		x		løs	<b>5121-608120</b>



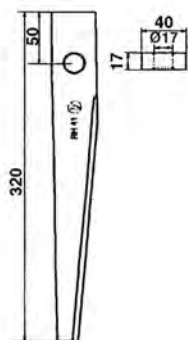

### 100 - serien

Pos.	Benævnelse	Original	Uoriginal	Anv. på pos.	Pk/bdt.str. eller løse	Grp.-varenummer
	Rotorharvetand, std., højre & venstre		x		løs	<b>5121-52503700</b>
	Bolt t/do, M16 x 1,5 x 55 mm, KV. 12.9		x		løs	<b>5121-1655</b>
	Låsemøtrik m/krave, M16 x 1,5 KV.12.9		x		løs	<b>5121-80201662</b>

Længde meter	Antal tænder højre	Antal tænder venstre
3,0	20	20
4,0	26	26

## Kuhn

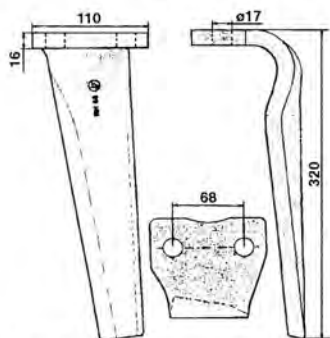

Illustrationen viser venstre model

### 1000 - serien

Pos.	Benævnelse	Original	Uoriginal	Anv. på pos.	Pk/bdt.str. eller løse	Grp.-varenummer
	Rotorharvetand, højre		x		løs	<b>5121-52539400</b>
	Rotorharvetand, venstre		x		løs	<b>5121-52539500</b>
	Bolt m/låsemøtrik t/do, M16 x 1,5 x 60 mm, Kv. 12.9		x		løs	<b>5121-1660</b>
	Låsemøtrik m/krave, M16 x 1,5 Kv.12.9		x		løs	<b>5121-80201662</b>
	Rotorharvet. m/rapidbelægn., højre		x		løs	<b>5121-52556400</b>
	Rotorharvet. m/rapidbelægn., venstre		x		løs	<b>5121-52556500</b>

Længde meter	Antal tænder højre	Antal tænder venstre
3,0	10	10
4,0	14	12

## Afstryger

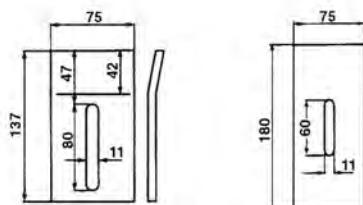

### Til Kuhn pakkevalse

Pos.	Benævnelse	Original	Uoriginal	Anv. på pos.	Pk/bdt.str. eller løse	Grp.-varenummer
1	Afstryger, 137 x 75 x 3 mm		x		løs	<b>5121-52532120</b>
2	Plastafstryger, 180 x 75 mm		x		løs	<b>5121-525321200</b>

Længde meter	Antal afskrabere
3,0	28
4,0	37

## Krone

3.052

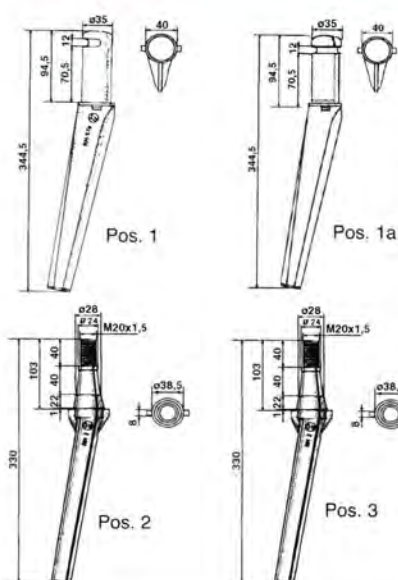

Pos.	Benævnelse	Original	Uoriginal	Anv. på pos.	Pk/bdt.str. eller løse	Grp.-varenummer
1	Rotorharvetand 1)		x		løs	<b>5121-4904372</b>
1a	Rotorharvetand 2)		x		løs	<b>5121-1</b>
	Spannit, M10 x 70 mm t/4904372		x		25	<b>1113-100070</b>
2	Rotorharvetand, 330 m		x		løs	<b>5121-4913940</b>
3	Rotorharvetand, 365 mm		x		løs	<b>5121-4914020</b>
	Konisk låsemøtrik, M20 x 1,5		x		løs	<b>5121-20</b>

- 1) Kan kun monteres i en stilling  
 2) Kan monteres i flere stillinger (større bearbejdningsradius).

## Lely, Landsberg & Rau

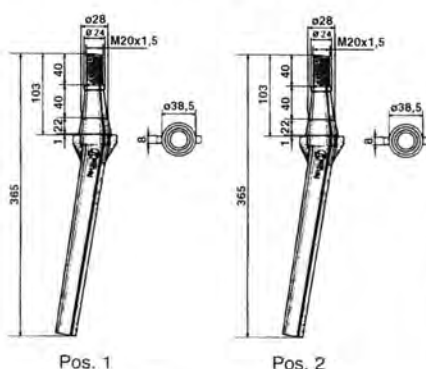

Pos.	Benævnelse	Original	Uoriginal	Anv. på pos.	Pk/bdt.str. eller løse	Grp.-varenummer
1	Rotorharvetand, 330 mm, Lely		x		løs	<b>5121-1169902200</b>
1	Rotorharvetand, Landsberg		x		løs	<b>5121-1160603150</b>
1	Rotorharvetand, Rau		x		løs	<b>5121-E15711</b>
2	Rotorharvetand, 365 mm, Lely		x		løs	<b>5121-4914020</b>
2	Rotorharvetand, Rau		x		løs	<b>5121-24025</b>
	Konisk låsemøtrik, M20 x 1,5		x		løs	<b>5121-20</b>

## Afstrygere til Lely pakkevalse

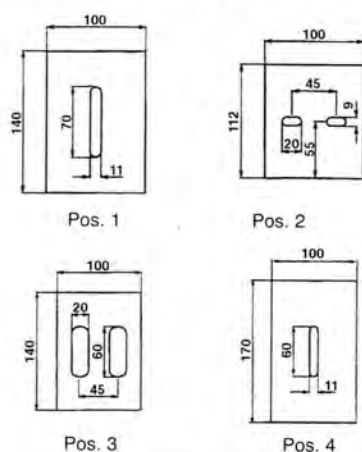

Pos.	Benævnelse	Original	Uoriginal	Anv. på pos.	Pk/bdt.str. eller løse	Grp.-varenummer
1	Afstryger, 140 x 100 mm		x		løs	<b>5121-116322304</b>
2	Afstryger, 112 x 100 mm		x		løs	<b>5121-116452944</b>
3	Plastafstryger, 100 x 140 x 10 mm		x		løs	<b>5121-1164529440</b>
4	Plastafstryger, 100 x 170 x 10 mm		x		løs	<b>5121-163223040</b>



## Maschio

3.053

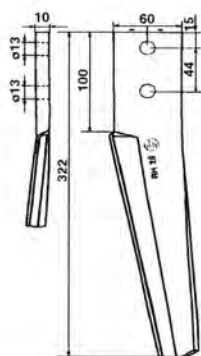

Illustrationen viser venstre model

### Maschio, model HB/HM.

Passer også på visse Dondi & Köckerling

Pos.	Benævnelse	Original	Uoriginal	Anv. på pos.	Pk/bdt.str. eller løse	Grp.-varenummer
	Rotorharvetand, højre, 10 mm		x		løs	5121-10100257
	Rotorharvetand, venstre, 10 mm		x		løs	5121-10100258
	Rotorharvetand, højre, 12 mm		x		løs	5121-10100262
	Rotorharvetand, venstre, 12 mm		x		løs	5121-10100263
	Bolt t/do, 12 x 1,25 x 45 mm		x		løs	5121-1245
	Låsemøtrik M12 x 1,25		x		løs	5121-12

## Maschio

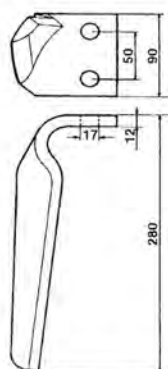

Illustrationen viser højre model

### Maschio, model Delfino, Daino, Drago, Diamante.

Passer også på visse Falc, Maletti/Kverneland & Vogel & Noot, serie M

Pos.	Benævnelse	Original	Uoriginal	Anv. på pos.	Pk/bdt.str. eller løse	Grp.-varenummer
	Rotorharvetand, højre, Maschio		x		løs	5121-27100209
	Rotorharvetand, venstre, Maschio		x		løs	5121-27100210
	Rotorharvetand, H, Vogel & Noot		x		løs	5121-V05494
	Rotorharvetand, V, Vogel & Noot		x		løs	5121-V05493
	Rotorharvetand, højre, Falc		x		løs	5121-512075
	Rotorharvetand, venstre, Falc		x		løs	5121-512076
	Bolt til do., M16 x 1,5 x 55 mm, KV 12.9		x		løs	5121-1655
	Låsemøtrik m/krave, M16		x		løs	5121-80201662

## Maschio

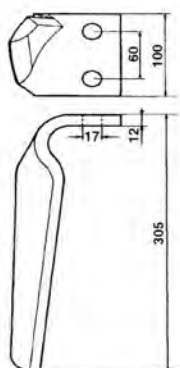

Illustrationen viser højre model

### Maschio, model Dominator.

Passer også på visse Aquila, Vigolo & Vogel & Noot

Pos.	Benævnelse	Original	Uoriginal	Anv. på pos.	Pk/bdt.str. eller løse	Grp.-varenummer
	Rotorharvetand, højre, Maschio		x		løs	5121-36100210
	Rotorharvetand, venstre, Maschio		x		løs	5121-36100211
	Rotorharvetand, H, Vogel & Noot		x		løs	5121-V05591
	Rotorharvetand, V, Vogel & Noot		x		løs	5121-V05590
	Bolt til do, M16 x 1,5 x 55 mm, KV 12.9		x		løs	5121-1655
	Låsemøtrik m/krave, M16		x		løs	5121-80201662

Længde meter	Antal tænder højre	Antal tænder venstre
3,0	12	12
3,5	14	14
4,0	16	16
4,5	18	18
5,0	20	20

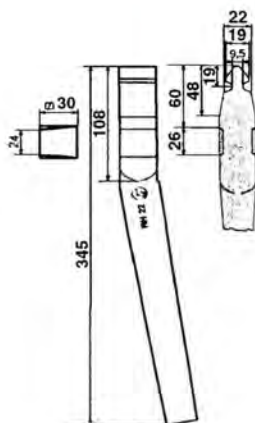

Passer også på visse Landsberg, Simca, Vogel & Noot, Maletti/Kverneland

Pos.	Benævnelse	Original	Uoriginal	Anv. på pos.	Pk/bdt.str. eller løse	Grp.-varenummer
	Rotorharvetand, højre & venstre		x		løs	<b>5121-8611</b>
	Rotorharvetand, Landsberg		x		løs	<b>5121-053800</b>
	Rotorharvetand, Sicma		x		løs	<b>5121-5012</b>

Befa: Længde meter	Antal tænder højre	Antal tænder venstre
2,0	16	16
2,5	20	20
3,0	24	24
3,5	28	28
4,0	32	32

## Maletti/Kverneland

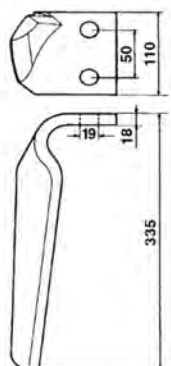

Illustrationen viser højre model

Pos.	Benævnelse	Original	Uoriginal	Anv. på pos.	Pk/bdt.str. eller løse	Grp.-varenummer
	Rotorharvetand, venstre		x		løs	<b>5121-70146</b>
	Rotorharvetand, højre		x		løs	<b>5121-80146</b>

## Kongskilde

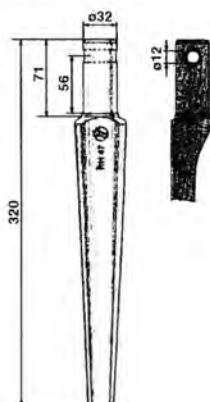

Kongskilde, model RD, rotormaster.

Passer også på visse Pergoraro & Rau

Pos.	Benævnelse	Original	Uoriginal	Anv. på pos.	Pk/bdt.str. eller løse	Grp.-varenummer
	Rotorharvetand, H & V, Kongsk.		x		løs	<b>5121-51001430</b>
	Rotorharvetand, H. & V., Pegoraro		x		løs	<b>5121-1205101</b>
	Rotorharvetand, H. & V., Rau		x		løs	<b>5121-18037</b>
	Spannit, M12 x 60 mm		x		løs	<b>1113-120060</b>

Model	Længde meter	Antal tænder
RD250	2,5	20
RD300	3,0	24
RD400	4,0	32



## Kongskilde

3.055

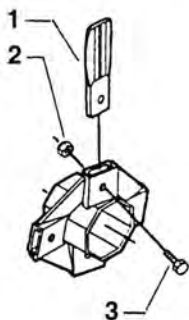

### Kongskilde, model Elliptor, EL3000 & EL4000

Pos.	Benævnelse	Original	Uoriginal	Anv. på pos.	Pk/bdt.str. eller løse	Grp.-varenummer
1	Kniv	x			løs	<b>5121-07300314</b>
2	Stålsætbolt, M16 x 45, 8.8		x			<b>0222-16045</b>
3	Låsemøtrik, M16		x			<b>0440-16</b>

Model	Længde meter	Antal tænder
EL3000	3,0	88
EL4000	4,0	120

## Afstryger, Pegoraro, Kongskilde-Elliptor

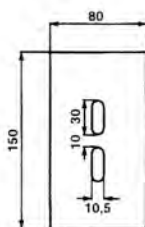

Pos. 1

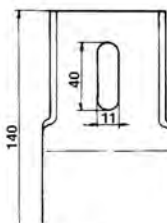

Pos. 2

Pos.	Benævnelse	Original	Uoriginal	Anv. på pos.	Pk/bdt.str. eller løse	Grp.-varenummer
1	Afstryger, 150 x 80 x 2,5 mm		x		løs	<b>5121-006567</b>
2	Afstryger, 140 x 80 x 4 mm	x			løs	<b>5125-07300454</b>

## Niemeyer

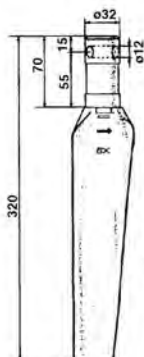

Illustrationen viser venstre model

### Niemeyer, model KR25, 30 og 4020.

Passer også på visse Euroma

Pos.	Benævnelse	Original	Uoriginal	Anv. på pos.	Pk/bdt.str. eller løse	Grp.-varenummer
	Rotorharvetand, højre		x		løs	<b>5121-034000</b>
	Rotorharvetand, venstre		x		løs	<b>5121-034001</b>
	Spændestift, M12 x 60 mm		x		10	<b>1113-120060</b>

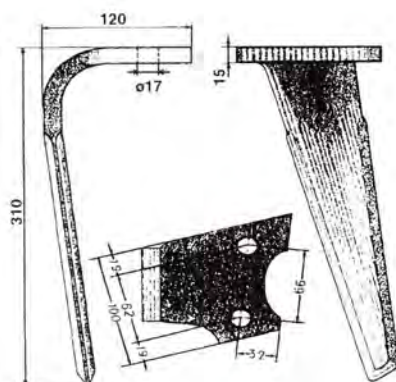

Illustrationen viser venstre model

### Model KG30, RKE, PKE

Pos.	Benævnelse	Original	Uoriginal	Anv. på pos.	Pk/bdt.str. eller løse	Grp.-varenummer
	Rotorharvetand, højre		x		løs	<b>5121-84045001</b>
	Rotorharvetand, venstre		x		løs	<b>5121-84045002</b>
	Rotorharvetand, højre m/rapidbelægning		x	løs		<b>5121-84116203</b>
	Rotorharvetand, venstre m/rapidbelægning		x	løs		<b>5121-84116204</b>
	Bolt m/låsemøtrik t/do, M16 x 1,5 x 60 mm, Kv. 12.9		x	løs		<b>5121-1660</b>
	Låsemøtrik m/krave M16		x		løs	<b>5121-80201662</b>

Længde meter	Antal tænder
2,5	20
3,0	24
3,5	28
4,0	32

## Rabe

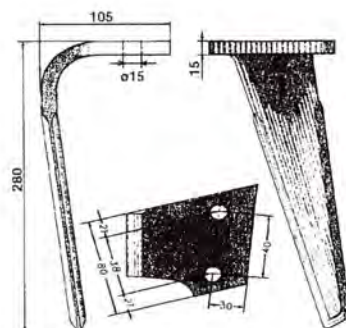

Illustrationen viser venstre model

### Model KG26, EMKE, WMKE, MKE

Pos.	Benævnelse	Original	Uoriginal	Anv. på pos.	Pk/bdt.str. eller løse	Grp.-varenummer
	Rotorharvetand, højre		x		løs	<b>5121-84091201</b>
	Rotorharvetand, venstre		x		løs	<b>5121-84091202</b>
	Rotorharvetand, højre m/rapidbelægning		x		løs	<b>5121-84116205</b>
	Rotorharvetand, venstre m/rapidbelægning		x		løs	<b>5121-84116206</b>
	Bolt t/do, M14 x 1,5 x 50 mm, Kv. 12.9		x		løs	<b>5121-1450</b>
	Låsemøtrik m/krave M14		x		løs	<b>5121-14</b>

Længde meter	Antal tænder
2,5	20
3,0	24
3,5	28
4,0	32



## Rabe

3.057

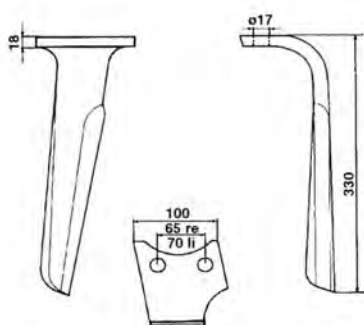

Illustrationen viser højre model

### Model KG41, SKE

Pos.	Benævnelse	Original	Uoriginal	Anv. på pos.	Pk/bdt.str. eller løse	Grp.-varenummer
	Rotorharvetand, højre		x		løs	<b>5121-84231801</b>
	Rotorharvetand, venstre		x		løs	<b>5121-84231802</b>
	Rotorharvetand, højre m/rapidbelægning		x		løs	<b>5121-84116207</b>
	Rotorharvetand, venstre m/rapidbelægning		x		løs	<b>5121-84116208</b>
	Bolt m/låsemøtrik t/do, M16 x 1,5 x 60 mm, Kv. 12.9		x		løs	<b>5121-1660</b>
	Låsemøtrik m/krave M16		x		løs	<b>5121-80201662</b>

Længde meter	Antal tænder
2,5	20
3,0	24
3,5	28
4,0	32

## Afstryger

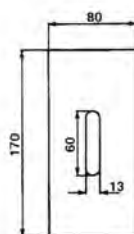

Pos. 1

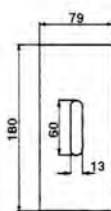

Pos. 2

### Rabe

Pos.	Benævnelse	Original	Uoriginal	Anv. på pos.	Pk/bdt.str. eller løse	Grp.-varenummer
1	Afstryger, 170 x 80 mm		x		løs	<b>5121-84050027</b>
2	Plastafstryger, 180 x 79 mm		x		løs	<b>5121-840500270</b>

Længde meter	Antal afstrygere
3,0	24
4,0	34

## Afstryger

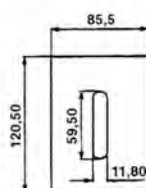

### Kverneland

Pos.	Benævnelse	Original	Uoriginal	Anv. på pos.	Pk/bdt.str. eller løse	Grp.-varenummer
	Afstryger, 120 x 85 mm		x		løs	<b>5121-120085</b>

## Spaderulleknive

3.058

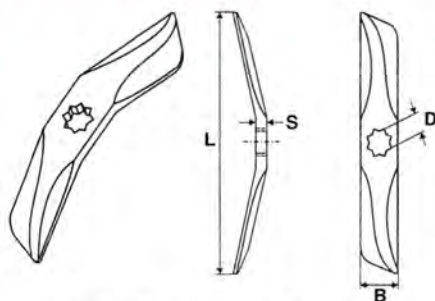

Illustrationen viser højre model

### Hankmo/Omme

Pos.	Benævnelse	Original	Uoriginal	Anv. på pos.	Pk/bdt.str. eller løse	Grp.-varenummer
	Spaderullekniv, højre (illustreret)		x			<b>5121-31380</b>
	Spaderullekniv, venstre		x			<b>5121-31381</b>

L	S	B	D
380	10	70	31

## Bomford

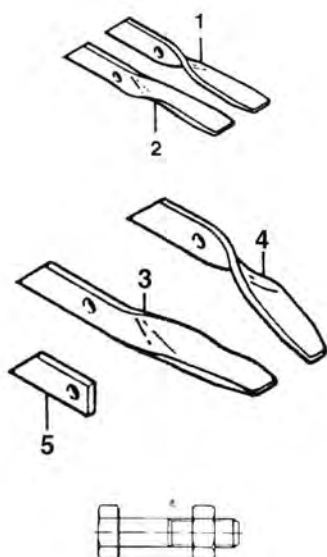

### Model Dyna - Drive

Pos.	Benævnelse	Original	Uoriginal	Anv. på pos.	Pk/bdt.str. eller løse	Grp.-varenummer
1	Tand, højre, 40 x 12 mm		x		løs	<b>5121-0396109</b>
1	Jumbo-tand, højre, 50 x 12 mm		x		løs	<b>5121-0694901</b>
2	Tand, venstre, 40 x 12 mm		x		løs	<b>5121-0396110</b>
2	Jumbo-tand, venstre, 50 x 12 mm		x		løs	<b>5121-0694902</b>
3	Rensetand, højre, 40 x 12 mm		x		løs	<b>5121-0404505</b>
4	Rensetand, venstre, 40 x 12 mm		x		løs	<b>5121-0404504</b>
5	Støttetand, 50 x 12 mm		x		løs	<b>5121-0695001</b>
6	Specialbolt m/klemmøtrik, M12 x 1,25 x 42 mm		x		50	<b>5121-0577503</b>
	Kæde, Duplex, 50 led t/do Flangeleje v/knivrotor Y-flangelejehus, SKF				5 m	<b>8010-3220D</b> <b>7500-YAR211-50-RF</b> <b>7500-FY511M</b>

Længde meter	Antal tænder højre	Antal tænder venstre
2,4	62	62
3,0	80	80
3,4	92	92
3,8	104	104
4,4	122	122
5,0	140	140



Howard

3.059

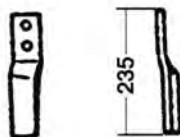

### Model Rotalabour HR 40 - 50

Pos.	Benævnelse	Original	Uoriginal	Anv. på pos.	Pk/bdt.str. eller løse	Grp.-varenummer
	Tand, venstre, 235 x 60 x 12 mm	x			løs	<b>5121-1653256</b>
	Tand, højre, 235 x 60 x 12 mm	x			løs	<b>5121-1653257</b>
	Bolt m/låsemøtrik t/do., M16 x 1,5 x 60 mm, Kv. 12.9		x		løs	<b>5121-1660</b>
	Låsemøtrik m/krave, M16		x		løs	<b>5121-80201662</b>
	Fjederskive, 16 mm		x		100	<b>0562-16</b>

Længde meter	Antal tænder højre	Antal tænder venstre
2,30	36	36
2,55	40	40
3,05	48	48
4,05	64	64

Howard



### Model Rotalabour med F-1 rotor, HR 40 - 50 - 60

Pos.	Benævnelse	Original	Uoriginal	Anv. på pos.	Pk/bdt.str. eller løse	Grp.-varenummer
	Tand, venstre, 250/210 x 60 x 12 mm	x			løs	<b>5121-1653828</b>
	Tand, højre, 250/210 x 60 x 12 mm	x			løs	<b>5121-1653829</b>
	Bolt t/do. M16 x 40 mm		x			<b>0222-16040</b>
	Låsemøtrik t/do. M16		x			<b>0440-16</b>

Afstryger

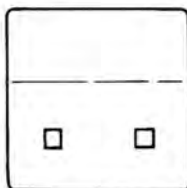

### Howard, model HR 30 - 40 - 50

Pos.	Benævnelse	Original	Uoriginal	Anv. på pos.	Pk/bdt.str. eller løse	Grp.-varenummer
	Afstryger, 100 x 100 x 5 mm	x				<b>5121-1652882</b>

## Granatharvetand

3.060

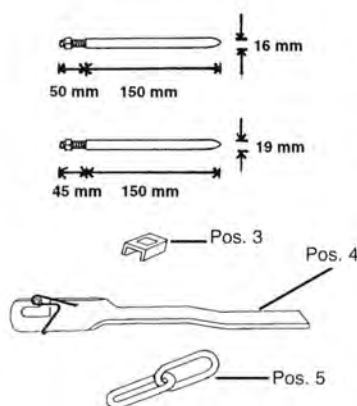

### Passende til Flemstofte

Pos.	Benævnelse	Original	Uoriginal	Anv. på pos.	Pk/bdt.str. eller løse	Grp.-varenummer
1	Granatharvetand, 16 mm, m/12 mm møtrik	x			25	5150-80010026
2	Granatharvetand, 19 mm, m/16 mm møtrik	x			20	5150-80010027
3	Tandstøtte t/16 mm tand	x			løs	5150-80010028
3	Tandstøtte t/19 mm tand	x			løs	5150-80010029
4	Trækkrog m/låsefjeder	x			løs	5150-80010024
4	Låsefjeder t/trækkrog	x			løs	5150-80010025
5	Trækkædeled	x			løs	5150-80010023

## Ukrudtsharvetand



	Rud. Sack tand, 20 x 14 mm m/1/2" møtrik 170 mm arbejdslængde		x			5220-U8
--	--	--	---	--	--	---------

## Spidsharvetænder med møtrik

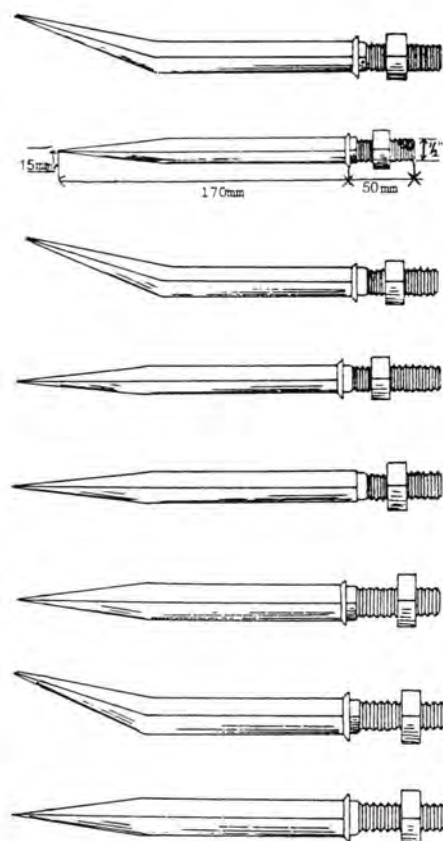

Pos.	Benævnelse	Original	Uoriginal	Anv. på pos.	Pk/bdt.str. eller løse	Grp.-varenummer
	15 x 170 mm - krum m/firkantet ansats & bryst, 40 mm gevindtap x 1/2" gevind		x	50		5150-P16
	15 x 170 mm - lige m/firkantet ansats & bryst, 50 mm gevindtap x 1/2" gevind		x		50	5150-P17
	15 x 170 mm - krum m/rund ansats & bryst, 40 mm gevindtap x 1/2" gevind		x		50	5150-P26
	15 x 170 mm - lige m/rund ansats & bryst, 40 mm gevindtap x 1/2" gevind		x		50	5150-P27
	15 x 170 mm - lige m/rund ansats u/bryst, 40 mm gevindtap x 1/2" gevind		x		50	5150-P35
	18 x 190 mm - lige m/firkantet ansats & bryst, 50 mm gevindtap x 9/16" gev.		x		50	5150-P45
	18 x 190 mm - krum m/firkantet ansats & bryst, 50 mm gevindtap x 9/16" gev.		x		50	5150-P46
	18 x 190 mm - lige m/rund ansats & bryst, 50 mm gevindtap x 9/16" gev.		x		50	5150-P55

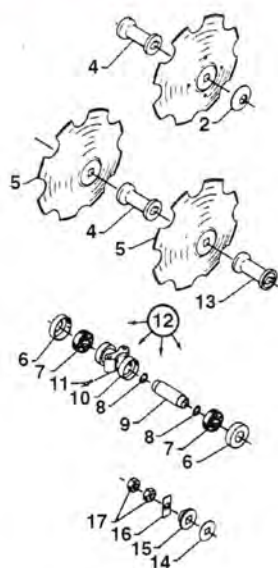

Disco-Dan, let model

Pos.	Benævnelse	Original	Uoriginal	Anv. på pos.	Pk/bdt.str. eller løse	Grp.-varenummer
	Ny model:					
2	Endestykke, K13	x				5115-0413400
4	Afstandsstykke, glat, K11	x				5115-1011130
6	Lejedæksel	x				5115-1011120
7	Erst. af 7200-6210Z					5115-0473210
9	Lejebøsning	x				5115-1011110
10	Lejehus K15	x				5115-1011100
12	Lejehus kpl.	x				5115-1011090
13	Afstandsstykke, grigang, K11A	x				5115-1011140
14	Mellemlægsskive	x				5115-1022560
15	Låseklods, K12	x				5115-0413300
16	Låseblink	x				5115-1011150
17	Erst. af 0404-27	x				5115-0262280
5	Tallerken, 20" m/8 udskæringer, hulmål 28,5 x 28,5 mm		x			5240-0428000

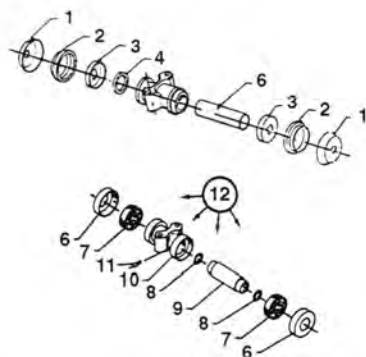

	Gl. model:					
1	Udvendig lejedæksel	x				5115-1033380
2	Gummipakning	x				5115-0483500
3	Indvendig lejedæksel	x				5115-1033370
4	Trykring	x				5115-0484500
6	Lejebøsning	x				5115-1033360
12	Leje kpl. (1033340)	x				5115-1011090

### Dele til topgalge



Disco-Dan, let model

Pos.	Benævnelse	Original	Uoriginal	Anv. på pos.	Pk/bdt.str. eller løse	Grp.-varenummer
	Trækkæde	x				5115-1011240
	Lifftap	x				5115-1011300

### Dele til cylinder

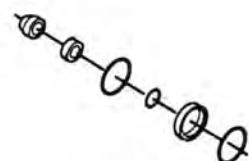

Disco-Dan, let model

Pos.	Benævnelse	Original	Uoriginal	Anv. på pos.	Pk/bdt.str. eller løse	Grp.-varenummer
	Pakningssæt kpl.					5115-0461270
	Pakningssæt kpl.	x				5115-0462070





### Disco-Dan, let model

Pos.	Benævnelse	Original	Uoriginal	Anv. på pos.	Pk/bdt.str. eller løse	Grp.-varenummer
	Skraber, type 1	x				5115-1011170
	Skraber, type 2	x				5115-1011180

### Stegsted, Sdr. Omme



Pos.	Benævnelse	Original	Uoriginal	Anv. på pos.	Pk/bdt.str. eller løse	Grp.-varenummer
	Tallerken, 20" m/10 udskæringer, hulmål 31,5 x 31,5 mm		x			5230-26-0080

### Doublet Rekord



#### Mega-Dan

Pos.	Benævnelse	Original	Uoriginal	Anv. på pos.	Pk/bdt.str. eller løse	Grp.-varenummer
	Tallerken, Ø510 mm		x			5115-0428050

### Kverneland



Pos.	Benævnelse	Original	Uoriginal	Anv. på pos.	Pk/bdt.str. eller løse	Grp.-varenummer
	Tallerken, 20" m/8 udskæringer hulmål 30 x 30 mm		x			5240-121205
	Tallerken, 24", glat hulmål 39 x 39 mm		x			5240-121208
	Tallerken, 24" m/9 udskæringer hulmål 39 x 39 mm		x			5240-121209
	Flanget, 55 mm, rund		x			7500-MS100

### Fiskars



Pos.	Benævnelse	Original	Uoriginal	Anv. på pos.	Pk/bdt.str. eller løse	Grp.-varenummer
	Tallerken, 20" m/10 udskæringer hulmål 33 x 33 mm		x			5240-95001534
	Tallerken, 24", glat hulmål 33 x 33 mm		x			5240-95001535
	Konisk leje med firk. hul		x			5240-61188110
	Yderring til do.		x			5240-61188100
	Pakdåse		x			5240-82262510

## Einböck

3.063

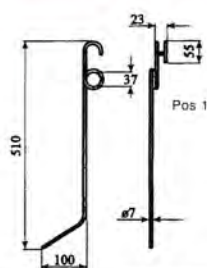

Pos.	Benævnelse	Original	Uoriginal	Anv. på pos.	Pk/bdt.str. eller løse	Grp.-varenummer
1	Striglefjeder, 510 x 7 mm		x			5220-5107
1	Striglefjeder, 600 x 7 mm		x			5220-6007
2	Beslag t/striglefjeder		x			5220-10012
	Brædebolt, M8 x 70 mm		x			0352-08070

## Hatzenbichler

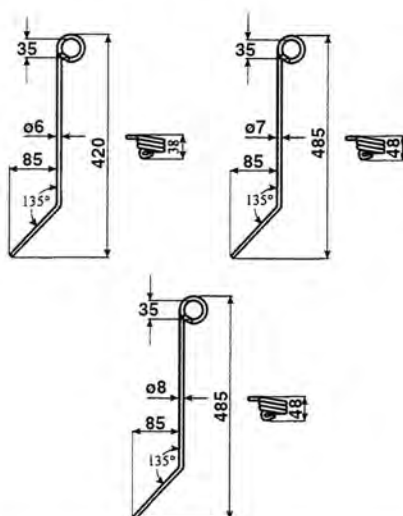

Pos.	Benævnelse	Original	Uoriginal	Anv. på pos.	Pk/bdt.str. eller løse	Grp.-varenummer
	Striglefjeder, 420 x 6 mm		x			5220-931126
	Striglefjeder, 485 x 7 mm		x			5220-931127
	Striglefjeder, 485 x 8 mm		x			5220-931128

## Köckerling

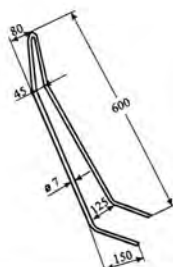

Pos.	Benævnelse	Original	Uoriginal	Anv. på pos.	Pk/bdt.str. eller løse	Grp.-varenummer
	Striglefjeder, 600 x 7 mm		x			5220-585072

## Doublet Rekord



Pos.	Benævnelse	Original	Uoriginal	Anv. på pos.	Pk/bdt.str. eller løse	Grp.-varenummer
	Striglefjeder	x				5115-0426700

Ovennævnte fjedre anvendes specielt til mekanisk ukrudtsbekæmpelse i stort set alle afgrøder samt til græsmarkspleje. Bruges især af mange økologiske jordbrug, som herved undgår sprøjtning med kemikalier

## Kongskilde

3.064



### Kulturharvespidser

Pos.	Antal huller	Mål tykk.	Farve	Original	Uoriginal	M/bolt	U/bolt	Bolt	Pk/bdt.str. eller løse	Grp.-varenummer
	1 hul	6	Blå		x	x		5003-1037	25	5120-1
	1 hul	6	Blå		x	x		5003-1037	25	5120-10-130/625
	1 hul	8	Sort		x			5003-1037	25	5120-10-130/8
	1 hul	6	Blå	x		x		5003-1037	50	5125-01000640
	1 hul	6	Grøn	x		x		5003-1037	25	5125-01000583

## Kverneland



### Kulturharvespidser

Pos.	Antal huller	Mål tykk.	Farve	Original	Uoriginal	M/bolt	U/bolt	Bolt	Pk/bdt.str. eller løse	Grp.-varenummer
	1 hul	6	Grøn		x	x		5003-1037	25	5120-10-145/625

## Multi Flex



### Kulturharvespidser

Pos.	Hul-afstand i mm	Mål tykk.	Farve	Original	Uoriginal	M/bolt	U/bolt	Bolt	Pk/bdt.str. eller løse	Grp.-varenummer
	25	6	Sølv		x		x	5005-08025	25	5120-10-003/6

## Til flad stilk



### Kulturharvespidser

Pos.	Hul-afstand i mm	Mål tykk.	Farve	Original	Uoriginal	M/bolt	U/bolt	Bolt	Pk/bdt.str. eller løse	Grp.-varenummer
	45	6	Sort		x		x	5001-1025	25	5120-10-065



Pos 1



Pos 2

### Kulturharvespidser

Pos.	Antal huller/hulafstand i mm	Mål tykk.	Farve	Original	Uoriginal	M/bolt	U/bolt	Bolt	Pk/bdt.str. eller løse	Grp.-varenummer
1	25		Sort		x		x	5001-1025		5120-10-080
2	1 hul		Sort		x		x	5003-1037	løs	5140-10-137



## Prela

3.065



### Kulturharvespidser

Pos.	Hul-afstand i mm	Mål tykk.	Far-ve	Original	Uoriginal	M/bolt	U/bolt	Bolt	Pk/bdt.str. eller løse	Grp.-varenummer
	25	5	Grøn		x		x	5005-08025		<b>5120-10-180</b>

## Marsk Stig

Efterårsspids

Forårsspids



Pos. 1

Pos. 2

### Kulturharvespidser

Pos.	Hul-afstand i mm	Mål tykk.	Far-ve	Original	Uoriginal	M/bolt	U/bolt	Bolt	Pk/bdt.str. eller løse	Grp.-varenummer
1	30	8	Blå		x		x	5001-1035	25	<b>5120-10-410</b>
1	30	8	Blå	x			x	5001-1035	25	<b>5130-01010062</b>
1	30	8	Blå	x		x		5001-1035	25	<b>5130-01010162</b>
2	30	8	Blå		x		x	5001-1035	25	<b>5120-10-412</b>
2	30	8	Blå	x			x	5001-1035	25	<b>5130-01010063</b>
2	30	8	Blå	x		x		5001-1035	25	<b>5130-01010163</b>

## Marsk Stig

Sporløsner

Model 7



Pos. 1

Pos. 2

### Kulturharvespidser

Pos.	Antal huller/hul-afstand i mm	Mål tykk.	Far-ve	Original	Uoriginal	M/bolt	U/bolt	Bolt	Pk/bdt.str. eller løse	Grp.-varenummer
1	30	Ø20	Sølv		x		x	5001-1035	25	<b>5120-10-411</b>
2*	1 hul	5	Blå	x			x	5001-1037	25	<b>5130-01010060</b>

\* B = 35 mm, L = 140 mm

## Lige spids



### Kulturharvespidser

Pos.	Antal huller	Mål tykk.	Far-ve	Original	Uoriginal	M/bolt	U/bolt	Bolt	Pk/bdt.str. eller løse	Grp.-varenummer
	1 hul	6	Sort		x		x	5003-1037	25	<b>5120-15-001</b>

## Germinator

3.066

### Spørløsner



Pos. 1



Pos. 2

### Kulturharvespidser

Pos.	Antal huller	Mål tykk.	Farve	Original	Uoriginal	M/bolt	U/bolt	Bolt	Pk/bdt.str. eller løse	Grp.-varenummer
1	1 hul	8	Blå		x	x		5003-1037	25	<b>5120-A4</b>
1	1 hul	6	Sort	x		x		5003-1037	50	<b>5125-01200229</b>
2	1 hul	6	Sort	x		x		5003-1037	10	<b>5125-01200231</b>

## Renseskær, 13,5 cm



### Kulturharvespidser

Pos.	Antal huller	Mål tykk.	Farve	Original	Uoriginal	M/bolt	U/bolt	Bolt	Pk/bdt.str. eller løse	Grp.-varenummer
	1 hul	4	Sort		x		x	5003-1037	25	<b>5120-10-143</b>
	1 hul	3	Sort	x		x		5003-1037	20	<b>5125-01019785</b>

## Renseskær, 20 cm



### Kulturharvespidser

Pos.	Antal huller	Mål tykk.	Farve	Original	Uoriginal	M/bolt	U/bolt	Bolt	Pk/bdt.str. eller løse	Grp.-varenummer
	1 hul	3	Sort		x		x	5003-1037	25	<b>5120-10-144</b>
	1 hul	3	Sort	x		x		5003-1037	10	<b>5125-01019786</b>

## Spørløsner/dobbelt spids



Pos. 1



Pos. 2

### Kulturharvespidser

Pos.	Antal huller	Mål tykk.	Farve	Original	Uoriginal	M/bolt	U/bolt	Bolt	Pk/bdt.str. eller løse	Grp.-varenummer
1	1 hul	6	Rød	x		x		5003-1037	18	<b>5125-01000646</b>
2	1 hul	6	Sort	x		x		5003-1037	10	<b>5125-01000652</b>

## Vibroflex 2 1/2"



### Stubharvespidser

Pos.	Hul-afstand i mm	Mål tykk.	Farve	Original	Uoriginal	M/bolt	U/bolt	Bolt	Pk/bdt.str. eller løse	Grp.-varenummer
	45	6	Sort		x		x	5125-00323128	10	<b>5140-40-004/6</b>
	45	8	Blå		x	x		5125-00323128	20	<b>5140-40004-820</b>
	45	8	Blå		x		x	5125-00323128	10	<b>5140-A45</b>
	45	8	Blå	x		x		5125-00323128	20	<b>5125-05000504</b>

## Vibroflex 4"

3.067



### Stubharvespidser

Pos.	Hul-afstand i mm	Mål tykk.	Farve	Original	Uoriginal	M/bolt	U/bolt	Bolt	Pk/bdt.str. eller løse	Grp.-varenummer
	45	8	Blå		x	x		5125-00323128	10	5140-40005-810
	45	8	Blå		x		x	5125-00323128	10	5140-A10
	45	6	Sort	x		x		5125-00323128	10	5125-05000485
	45	8	Blå	x		x		5125-00323128	10	5125-05000514

## Til flad stilk

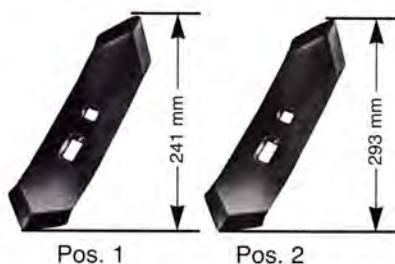

### Stubharvespidser

Pos.	Hul-afstand i mm	Mål tykk.	Farve	Original	Uoriginal	M/bolt	U/bolt	Bolt	Pk/bdt.str. eller løse	Grp.-varenummer
1	37,5/ 52,5	8	Grøn		x		x	5000-1245	10	5140-40-060/8
2	37,5/ 52,5	10	Sølv		x		x	5000-1250	10	5140-40-063/10

## Gåsefodslap 2 1/2"



### Stubharvespidser

Pos.	Antal huller	Mål tykk.	Farve	Original	Uoriginal	M/bolt	U/bolt	Bolt	Pk/bdt.str. eller løse	Grp.-varenummer
	1 hul	6	Blå		x		x	5003-1037	25	5140-10-131/6
	1 hul	4	Sort	x		x		5003-1037	50	5125-01000642
	1 hul	5	Blå	x		x		5003-1037	50	5125-01000650

## Gåsefodslap 4"



### Stubharvespidser

Pos.	Antal huller	Mål tykk.	Farve	Original	Uoriginal	M/bolt	U/bolt	Bolt	Pk/bdt.str. eller løse	Grp.-varenummer
	1 hul	4	Sort		x		x	5003-1037	25	5140-10-132/4
	1 hul	4	Sort	x		x		5003-1037	50	5125-01000644



## Renseskær 6" & 7"

3.068



### Stubharvespidser

Pos.	Antal huller	Mål tykk.	Farve	Original	Uoriginal	M/bolt	U/bolt	Bolt	Pk/bdt.str. eller løse	Grp.-varenummer
	1 hul	5	Sort		x		x	5003-1037	25	<b>5140-10-133/5</b> 5120-A30
	1 hul	4	Sort		x		x	5003-1037	25	

## Renseskær 13,5 cm



### Stubharvespidser

Pos.	Antal huller	Mål tykk.	Farve	Original	Uoriginal	M/bolt	U/bolt	Bolt	Pk/bdt.str. eller løse	Grp.-varenummer
	1 hul	4	Sort		x		x	5003-1037	25	<b>5120-10-143</b> <b>5125-01019785</b>
	1 hul	3	sort	x		x		5003-1037	20	

## Renseskær 20 cm



### Stubharvespidser

Pos.	Antal huller	Mål tykk.	Farve	Original	Uoriginal	M/bolt	U/bolt	Bolt	Pk/bdt.str. eller løse	Grp.-varenummer
	1 hul	3	Sort		x		x		25	<b>5120-10-144</b> <b>5125-01019786</b>
	1 hul	3	sort	x		x			10	

## Ugerløse radrennerskær

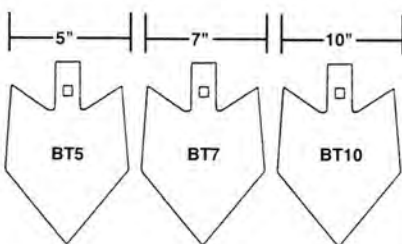

### Stubharvespidser

Pos.	Antal huller	Mål tykk.	Farve	Original	Uoriginal	M/bolt	U/bolt	Bolt	Pk/bdt.str. eller løse	Grp.-varenummer
	1 hul	3	Sort		x		x	5003-0833	25	<b>5290-BT5</b> <b>5290-BT7</b> <b>5290-BT10</b>
	1 hul	3	Sort		x		x	5003-0833	25	
	1 hul	3	sort		x		x	5003-0833	25	

## Lilla Harrie



### Stubharvespidser

Pos.	Hul-afstand i mm	Mål tykk.	Farve	Original	Uoriginal	M/bolt	U/bolt	Bolt	Pk/bdt.str. eller løse	Grp.-varenummer
	30	6	Rød		x		x	5000-1245	10	<b>5140-40-085</b>

## Fraugde

3.069



### Stubharvespidser

Pos.	Antal huller	Mål tykk.	Farve	Original	Uoriginal	M/bolt	U/bolt	Bolt	Pk/bdt.str. eller løse	Grp.-varenummer
	1 hul	8	Sølv		x		x	5125-00323128	10	5140-40-030/8

## Agrodan



### Stubharvespidser

Pos.	Hul-afstand i mm	Mål tykk.	Farve	Original	Uoriginal	M/bolt	U/bolt	Bolt	Pk/bdt.str. eller løse	Grp.-varenummer
1	50	12	Sort	x			x	5000-1245	10	5132-100562
2	50	12	Sort	x			x	5000-1245	10	5132-100572
3	50	12	Sort	x			x	5000-1245	10	5132-100561
5	50	6	Sølv	x			x	5000-1245	10	5132-100599
6	45	6	Sølv	x			x	5000-1245	10	5132-100563

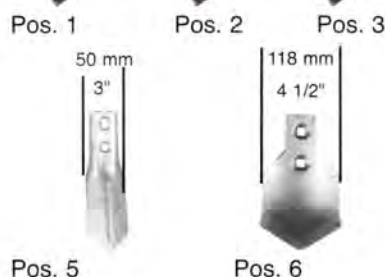

## Dobbelt hjertesvær

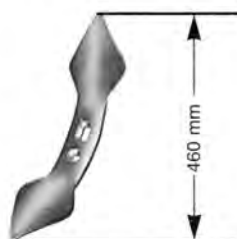

### Stubharvespidser

Pos.	Hul-afstand i mm	Mål tykk.	Farve	Original	Uoriginal	M/bolt	U/bolt	Bolt	Pk/bdt.str. eller løse	Grp.-varenummer
	45/60	16	Sort		x		x	5000-1260	5	5140-40-019

## Marsk Stig



### Stubharvespidser

Pos.	Antal huller	Mål tykk.	Farve	Original	Uoriginal	M/bolt	U/bolt	Bolt	Pk/bdt.str. eller løse	Grp.-varenummer
1	1 hul	8	Blå	x			x	5125-00323128	25	5130-01010064
1	1 hul	8	Blå	x		x		5125-00323128	25	5130-01010164
1	1 hul	8	Blå		x		x	5125-00323128	25	5140-A9
2	1 hul	8	Blå	x			x	5125-00323128	25	5130-01010065



## Planskær

3.070

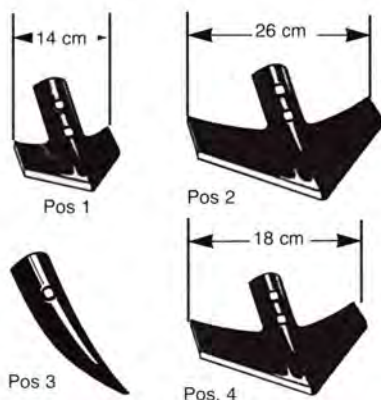

### Stubharvespidser

Pos.	Hul-afstand i mm	Mål tykk.	Far-ve	Original	Uoriginal	M/bolt	U/bolt	Bolt	Pk/bdt.str. eller løse	Grp.-varenummer
1	45	6	Sort	x		x		5125-00323128	20	5125-05000486
2	45	6	Sort	x		x		5125-00323128	10	5125-05000487
2	45	8	blå	x		x		5125-00323128	10	5125-05000584
3		6	Sort	x		x		5125-00323128	10	5125-05000488
4	40	8	blå	x		x		5125-00323128	10	5125-01000553

## Solbjerg-systemet



Vingskæret monteres mellem den vredne sølvspids og tanden

### Stubharvespidser

Pos.	Hul-afstand i mm	Mål tykk.	Far-ve	Original	Uoriginal	M/bolt	U/bolt	Bolt	Pk/bdt.str. eller løse	Grp.-varenummer
1	45/56	10	Sølv		x		x	5125-00323128	løs	5140-60317
1	45/56	10	Sølv		x	x		5125-00323128	10	5140-60317-10
2	45/56	10	Sølv		x		x	5125-00323128	løs	5140-60316
2	45/56	10	Sølv		x	x		5125-00323128	10	5140-60316-10
3	45/56	6	Sølv		x		x	5003-1260/70	løs	5140-60239
3	45/56	6	Sølv		x	x		5003-1260/70	10	5140-60239-10

Bruges spids og vingskær samlet, anvendes bolt 5003-1260 eller 5003-1270

"Åbningen" til tanden på vingskæret er ca. 55 mm

## Stenstrup-systemet

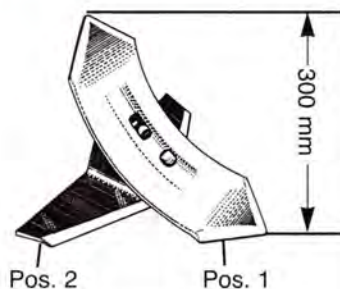

### Stubharvespidser

Pos.	Hul-afstand i mm	Mål tykk.	Far-ve	Original	Uoriginal	M/bolt	U/bolt	Bolt	Pk/bdt.str. eller løse	Grp.-varenummer
1	45/55	8	Blå		x		x	5003-1260	10	5140-A15
1	45/55	8	Blå		x		x	5003-1260	10	5140-A16
1	45/55	8	Blå		x		x	5003-1260	10	5140-A17
2	45/55	6	Blå		x		x	5003-1260	løs	5140-A18



## Stenstrup Non Stop

3.071

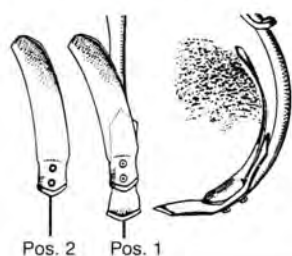

### Stubharvespidser

Pos.	Hul-afstand i mm	Mål tykk.	Farve	Original	Uoriginal	M/bolt	U/bolt	Bolt	Pk/bdt.str. eller løse	Grp.-varenummer
1	45	8	Blå		x		x	5003-1260	10	5140-A45
2	45	6	Blå		x		x	5003-1260	løse	5140-A46

## Kongskilde mixing skær



### Stubharvespidser

Pos.	Hul-afstand i mm	Mål tykk.	Farve	Original	Uoriginal	M/bolt	U/bolt	Bolt	Pk/bdt.str. eller løse	Grp.-varenummer
1	45	8	Blå	x		x		5003-1260	20	5125-05000649
2	45	6	Blå	x			x	5003-1260	10	5125-05000650

## Lemken smaragd, Howard Delta m.fl.

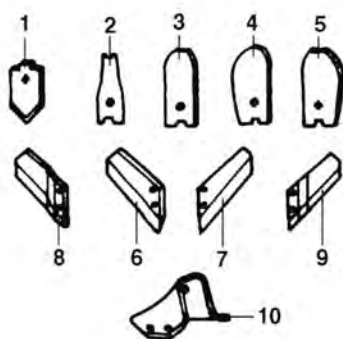

### Grubberspidser

Pos.	Antal huller/hulafstand i mm	Mål tykk.	Farve	Original	Uoriginal	M/bolt	U/bolt	Bolt	Pk/bdt.str. eller løse	Grp.-varenummer
1	1 hul	10	Blå		x	x		50081230	løse	5140-3374388
1	1 hul	12	Blå		x	x		50081230	løse	5140-3374392
2	1 hul	8	Blå		x	x		50001260	løse	5140-3374394
3	1 hul	8	Blå		x	x		50001260	løse	5140-3374395
4	1 hul	8	Blå		x	x		50001260	løse	5140-3374398
5	1 hul	8	Blå		x	x		50001260	løse	5140-3374399
6	70	10	Blå		x	x		50081230	løse	5140-3374416
7	70	10	Blå		x	x		50081230	løse	5140-3374417
8	70	10	Blå		x	x		50081230	løse	5140-3374418
8	70	11	Blå		x	x		50081230	løse	5140-3374420
9	70	10	Blå		x	x		50081230	løse	5140-3374419
9	70	11	Blå		x	x		50081230	løse	5140-3374421
10		10	Blå		x	x		50081230	løse	5140-4679105

## Väderstad/Wiberg



### Stubharvespidser

Pos.	Hul-afstand i mm	Mål tykk.	Farve	Original	Uoriginal	M/bolt	U/bolt	Bolt	Pk/bdt.str. eller løse	Grp.-varenummer
	37-90	13	sølv		x		x	5001260	løse	5140-60314
	37-90	13	sølv		x		x	5001260	løse	5140-60315

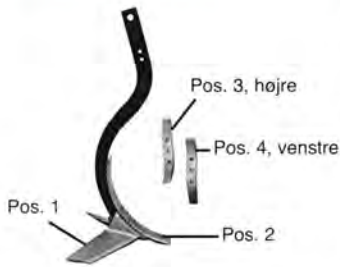

### Grubberspidser

Pos.	Hul-afstand i mm	Mål tykk.	Far-ve	Original	Uoriginal	M/bolt	U/bolt	Bolt	Pk/bdt.str. eller løse	Grp.-varenummer
1	80	8	Sølv	x			x	5000-1270	løs	5130-01010099
2	80	10	Sølv	x			x	5000-1270	5	5130-01010100
3	80	10	Sølv	x			x	5000-1270	5	5130-01010130
4	80	10	Sølv	x			x	5000-1270	5	5130-01010131

## Marsk Stig, Ratoon 1996

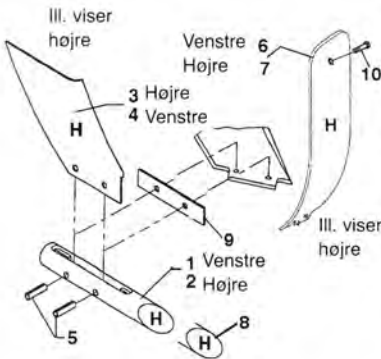

### Grubberspidser

Pos.	Hul-afstand i mm	Mål tykk.	Far-ve	Original	Uoriginal	M/bolt	U/bolt	Bolt	Pk/bdt.str. eller løse	Grp.-varenummer
1	100	Ø60	Sølv	x		x			løs	5130-49010107
2	100	Ø60	Sølv	x		x			løs	5130-49010106
3	100	4	Sølv	x			x	0316-16060	løs	5130-49010024
4	100	4	Sølv	x			x	0316-16060	løs	5130-49010025
6	100	15	Blå	x				0210-16065+ 0210-24080	løs	5130-49010001
7	100	15	Blå	x				0210-16065+ 0210-24080	løs	5130-49010002
8		Ø60		x					løs	5130-49010108
9	100			x					løs	5130-49010023
10				x					løs	5130-90060095

## Marsk Stig, Ratoon 1995

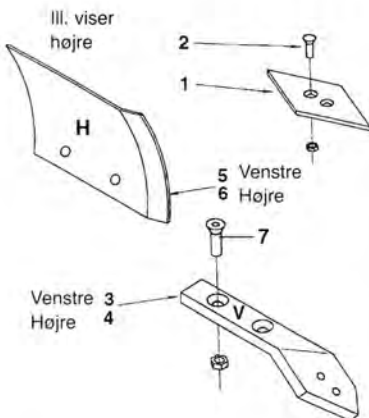

### Grubberspidser

Pos.	Antal huller/hulafstand i mm	Mål tykk.	Far-ve	Original	Uoriginal	M/bolt	U/bolt	Bolt	Pk/bdt.str. eller løse	Grp.-varenummer
1	35	12	Sølv	x			x	5000-1045	løs	5130-49010010
3	35/100	12	Sølv	x			x	0316-16060	løs	5130-49010011
4	35/100	12	Sølv	x			x	0316-16060	løs	5130-49010012
5	100	4	Sølv	x			x	0316-16060	løs	5130-49010013
6	100	4	Sølv	x			x	0316-16060	løs	5130-49010014



## Doublet Rekord, Mega Dan

3.073

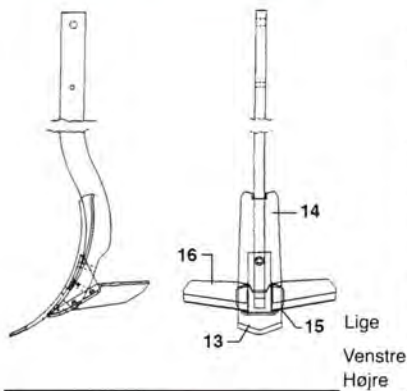

### Stubharvespidser

Pos.	Antal huller	Mål tykk.	Farve	Original	Uoriginal	M/bolt	U/bolt	Bolt	Pk/bdt.str. eller løse	Grp.-varenummer
13	1 hul	9	Blå	x		x		5040-013332	løs	5115-0423100
14	1 hul	9	Blå	x		x		5000-1280	løs	5115-0423150
14	1 hul	8	Blå	x		x		5000-1280	løs	5115-0423200
14	1 hul	8	Blå	x		x		5000-1280	løs	5115-0423250
15	1 hul	8	Blå	x		x		5000-1256	løs	5115-0423300
16	2	8	Blå	x		x		5000-1230	løs	5115-0423400
16	2	8	Blå	x		x		5000-1230	løs	5115-0423450

## Doublet Rekord, Grubber Dan



### Grubberspidser

Pos.	Hul-afstand i mm	Mål tykk.	Farve	Original	Uoriginal	M/bolt	U/bolt	Bolt	Pk/bdt.str. eller løse	Grp.-varenummer
	55	15	Sort	x			x	5000-1280	løs	5115-1040010

## Rabe



GG45



GG45L

### Vingskær

Pos.	Hul-afstand i mm	Mål tykk.	Farve	Original	Uoriginal	M/bolt	U/bolt	Bolt	Pk/bdt.str. eller løse	Grp.-varenummer
	60	8	Blå		x	x		5000-1030	løs	5140-GG45
	60	8	Blå		x	x		5000-1030	løs	5140-GG45L

## Bovlund

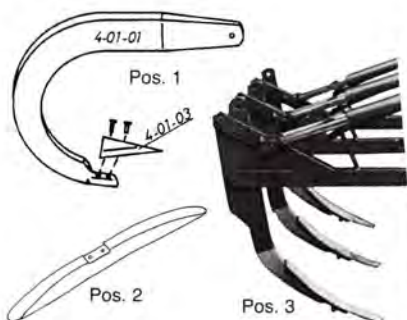

### Grubberspidser

Pos.	Hul-afstand i mm	Mål tykk.	Farve	Original	Uoriginal	M/bolt	U/bolt	Bolt	Pk/bdt.str. eller løse	Grp.-varenummer
1	37	7	Blå	x			x	5001-1150	løs	5010-40103
2	58	50	Blå	x			x	0278-16114	løs	5010-40151
3	90	12	Blå	x			x	5001-1670 5001-1680	løs	5010-40141



## Kverneland

3.074

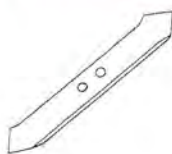

Pos. 1



Pos 2

### Grubberspidser

Pos.	Hul-afstand i mm	Mål tykk.	Far-ve	Original	Uoriginal	M/bolt	U/bolt	Bolt	Pk/bdt.str. eller løse	Grp.-varenummer
1	60	19	Sort	x		x		5020-031965	løs	5020-303107
2	60	19	Sort	x		x		5020-031975 0214-16060 0214-16070	løs løs løs	5020-303110

## Agrodan

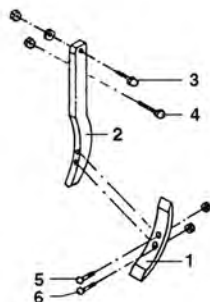

### Grubberspidser

Pos.	Hul-afstand i mm	Mål tykk.	Far-ve	Original	Uoriginal	M/bolt	U/bolt	Bolt	Pk/bdt.str. eller løse	Grp.-varenummer
1	75	25	Sort	x			x	5000-1680	løs	5132-100565
2								5000-1690	løs	5132-100569
5									25	5000-1680
6									25	5000-1690

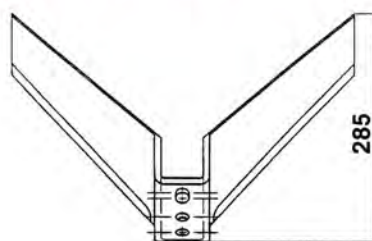

### Halmnedmuldere

Pos.	Benævnelse	Original	Uoriginal	Anv. på pos.	Pk/bdt.str. eller løse	Grp.-varenummer
	Vingeskær, Mammut. Passer på Dalbo-Dinco og på visse Præstbro, hvor vingeskæret ikke er delt		x			5140-60231

### Præstbro



### Halmnedmuldere

Pos.	Benævnelse	Original	Uoriginal	Anv. på pos.	Pk/bdt.str. eller løse	Grp.-varenummer
	Grubbeskær		x			5140-40-066

### Bolt til spidser og vingeskær

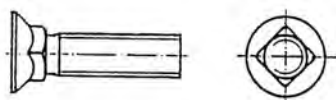

Pos.	Benævnelse	Original	Uoriginal	Anv. på pos.	Pk/bdt.str. eller løse	Grp.-varenummer
	Stålplovbolt, M12 x 60 mm, Kv. 8.8		x			5000-1260

Se også side 3.071 under Lemken Smaragd, der passer på visse Dalbo og Præstbro grubbere

## S-tænder

3.076

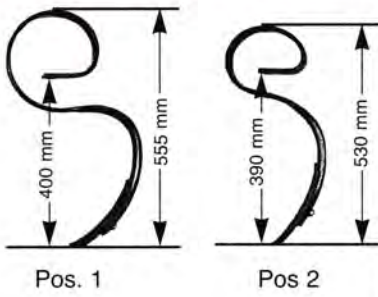

### Kulturharvetænder

Pos.	Tekst	Original	Uoriginal	Mont. m/spids Grp.-varenummer	Grp.-varenummer
1	S-tand, 32 x 10 mm		x	5120-10-130/625	<b>5110-1013</b>
1	S-tand, 32 x 10 mm		x	u/spids	<b>5110-300001</b>
1	S-tand, 32 x 10 mm	x		5125-01000640	<b>5125-01000669</b>
1	S-tand, 32 x 12 mm		x	5120-10-130/625	<b>5110-1072</b>
1	S-tand, Kulti Dan, 32 x 10 mm	x		5120-10-130/625	<b>5115-0422000</b>
2	Super Q-tand, 32 x 12 mm	x		5125-01000640	<b>5125-01000740</b>

## Vibro Corn/Beta

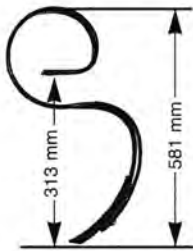

### Kulturharvetænder

Pos.	Tekst	Original	Uoriginal	Mont. m/spids Grp.-varenummer	Grp.-varenummer
	S-tand t/Vibro Corn, 32 x 12 mm	x		5125-01019785	<b>5125-01000760</b>

## Doublet Rekord

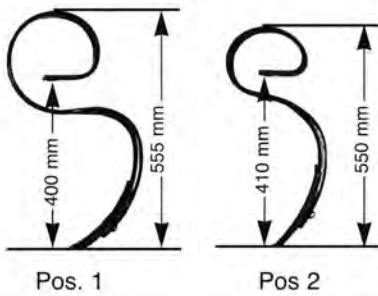

### Kulturharvetænder

Pos.	Tekst	Original	Uoriginal	Mont. m/spids Grp.-varenummer	Grp.-varenummer
1	S-tand, Combi Dan, Kulti Seeder, 32 x 10 mm	x		5120-10-130/625	<b>5115-0422100</b>
2	S-tand, Maxi/Master-Dan, 32 x 12 mm	x		5120-10-130/625	<b>5115-0422120</b>

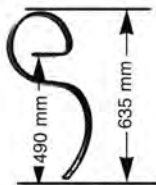

### Kulturharvetænder

Pos.	Tekst	Original	Uoriginal	Mont. m/spids Grp.-varenummer	Grp.-varenummer
	S-tand, 45 x 12 mm		x	u/spids	<b>5110-1061</b>



## Väderstad

3.077

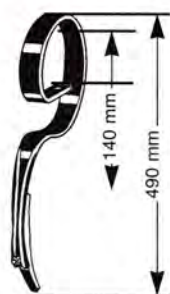

### Kulturharvetænder

Pos.		Original	Uoriginal	Mont. m/spids Grp.-varenummer	Grp.-varenummer
	Tekst				
	S-tand, Väderstad, 45 x 10 mm		x	u/spids	<b>5110-201470</b>

## Fraugde strongtand

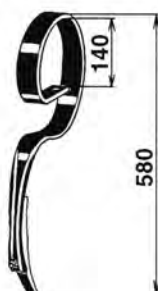

### Kulturharvetænder

Pos.		Original	Uoriginal	Mont. m/spids Grp.-varenummer	Grp.-varenummer
	Tekst				
	Strongtand, 32 x 10 mm		x	5120-10-145/625	<b>5110-300502</b>
	Strongtand, 45 x 10 mm		x	5120-10-145/625	<b>5110-300500</b>

## Combi-tand



### Kulturharvetænder

Pos.		Original	Uoriginal	Mont. m/spids Grp.-varenummer	Grp.-varenummer
	Tekst				
	Combitand, 45 x 9 mm		x	5120-10/131/6	<b>5110-J52</b>
	Hjælpefjeder				<b>5110-J52H</b>

## Germinatortand

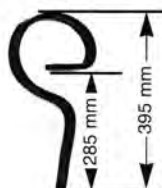

### Kulturharvetænder

Pos.		Original	Uoriginal	Mont. m/spids Grp.-varenummer	Grp.-varenummer
	Tekst				
	Germinatortand, 32 x 10 mm	x		5125-01200229	<b>5125-01200236</b>
	Germinatortand, 32 x 10 mm		x	5125-01200229	<b>5110-01200236</b>

## Combi-tand

3.078

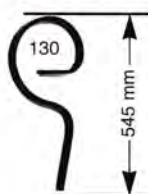

Pos. 1

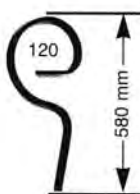

Pos 2

### Kulturharvetænder

Pos.	Tekst	Original	Uoriginal	Mont. m/spids Grp.-varenummer	Grp.-varenummer
1	Kulturharvetand, 32 x 10 mm		x	5120-15-001	<b>5110-1504</b>
2	Kulturharvetand, 32 x 12 mm		x	5120-15-001	<b>5110-1506</b>

## Prela

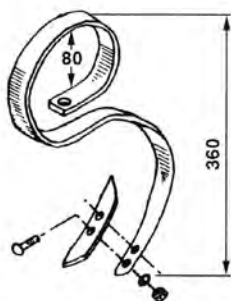

### Kulturharvetænder

Pos.	Tekst	Original	Uoriginal	Mont. m/spids Grp.-varenummer	Grp.-varenummer
	Prela-tand, 25 x 8 mm		x	5120-10-180	<b>5115-26-22900</b>

## Flamingo-tand



### Kulturharvetænder

Pos.	Tekst	Original	Uoriginal	Mont. m/spids Grp.-varenummer	Grp.-varenummer
	Tand kpl. 32 x 12 mm		x	5120-10-410	<b>5110-1015</b>

## Marsk Stig

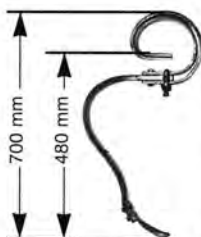

Pos. 1

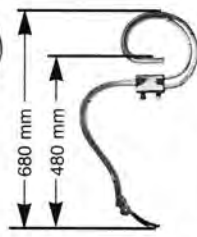

Pos. 2

### Kulturharvetænder

Pos.	Tekst	Original	Uoriginal	Mont. m/spids Grp.-varenummer	Grp.-varenummer
1	Kpl. tand, Marsk Stig, model 3				<b>5130-01010090</b>
2	Kpl. tand, Marsk Stig, model 4				<b>5130-01010087</b>

## Kverneland C-tand

3.079

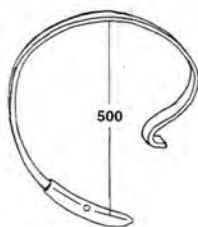

### Kulturharvetænder

Pos.	Tekst	Original	Uoriginal	Mont. m/spids Grp.-varenummer	Grp.-varenummer
	C-tand, rød, 32 x 10 mm, m/spids	x		5120-10-145/625	<b>5110-103009</b>
	C-tand, grøn, 32 x 10 mm, m/spids	x		5120-10-145/625	<b>5110-103012</b>

Den illustrerede tand er grøn model 103012.

På rød model 103009 går buen, hvor spændestykket placeres, den modsatte vej

## Marsk Stig Multi plus, MS-K model 7

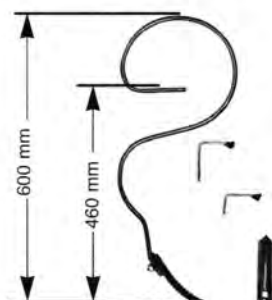

### Kulturharvetænder

Pos.	Tekst	Original	Uoriginal	Mont. m/spids Grp.-varenummer	Grp.-varenummer
	Tand kpl., 32 x 10 mm	x		5130-01010060	<b>5130-01010080</b>
	Tand kpl., 32 x 12 mm	x		5130-01010060	<b>5130-01010082</b>

## Doublet Rekord smuldreharve

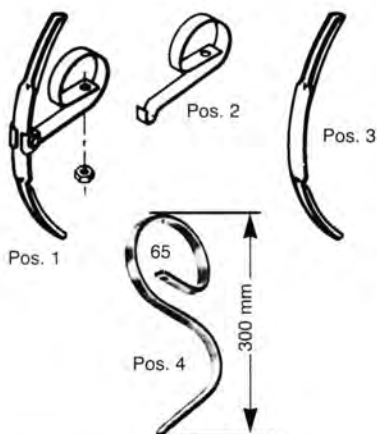

### Kulturharvetænder

Pos.	Tekst	Original	Uoriginal	Mont. m/spids Grp.-varenummer	Grp.-varenummer
1	Tand kpl., type 90	x		5115-0421700	<b>5115-0421500</b>
2	Overfjeder, type 90	x			<b>5115-0421600</b>
3	Vendbar spids, type 90	x			<b>5115-0421700</b>
4	Tand kpl., type 46/75		x		<b>5115-1014</b>

## Smuldreharvetand

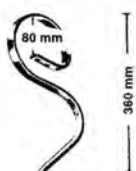

### Kulturharvetænder

Pos.	Tekst	Original	Uoriginal	Mont. m/spids Grp.-varenummer	Grp.-varenummer
	Smuldreharvetand, 25 x 8 mm		x		<b>5115-1017</b>



## Efterharvetand

3.080

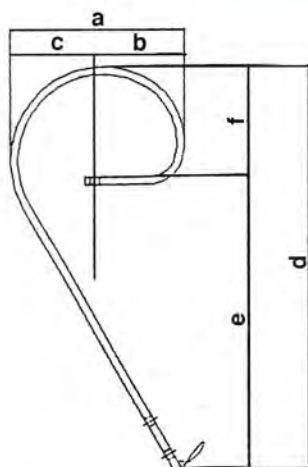

### Efterharvetænder

Pos.	Tekst	Original	Uoriginal	Mont. m/spids Grp.-varenummer	Grp.-varenummer
	Efterharvetand, 45 x 10 mm Passer på: Einböck Doublet rekord combisæt Holst Sørensen (Pløjboy) Dalbo combisæt		x	u/spids	5110-1225
a	b	c	d	e	f
mm	mm	mm	mm	mm	mm
234	121	113	533	387	146

## Efterharvetand

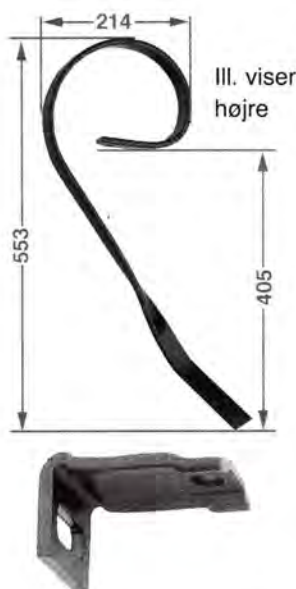

### Efterharvetænder

Pos.	Tekst	Original	Uoriginal	Mont. m/spids Grp.-varenummer	Grp.-varenummer
	Efterharvetand, H, 32 x 10 mm Efterharvetand, V, 32 x 10 mm Passer til bl.a.: Einböck Nordsten og Doublet rekord combisæt		x	u/spids	5110-1094
	Spændestykke t/bl. 50 x 50, td. 32 x 12		x	u/spids	5110-1095
					5110-432125050

## Kongskilde, Vibroflex

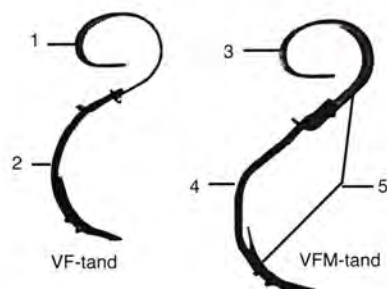

### Stubkultivatortænder

Pos.	Tekst	Original	Uoriginal	Mont. m/spids Grp.-varenummer	Grp.-varenummer
1	Overfjeder t/VF tand	x			5125-05000002
2	Fjederstilk t/VF tand	x			5125-05000128
3	Overfjeder t/VFM tand	x			5125-05150055
4	Fjederstilk t/VFM tand	x			5125-05150056
5	Kpl. VFM tand	x		5125-05000514	5125-05150135

## Doublet Rekord

3.081

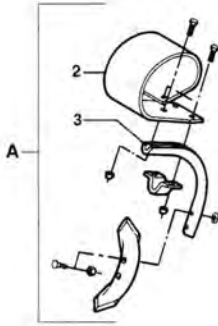

### Stubkultivatortænder

Pos.	Tekst	Original	Uoriginal	Mont. m/spids Grp.-varenummer	Grp.-varenummer
A	Kpl. stubharvetand	x		5125-05000504	5115-0422701
2	Overfjeder	x			5115-0422711
3	Undertand	x			5115-0422721

## Befa/Primoplex m.v.

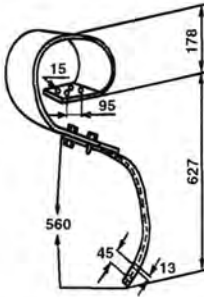

### Stubkultivatortænder

Pos.	Tekst	Original	Uoriginal	Mont. m/spids Grp.-varenummer	Grp.-varenummer
	Model David: Kpl. stubtand		x	5140-40005-810	5110-4047
	Overdel		x		5110-40300
	Underdel		x		5110-40218

## Sdr. Omme, Befa. m.fl.

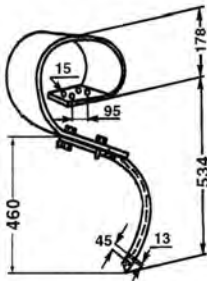

### Stubkultivatortænder

Pos.	Tekst	Original	Uoriginal	Mont. m/spids Grp.-varenummer	Grp.-varenummer
	Model David: Kpl. stubtand		x	5140-40004-820	5110-4030
	Overdel		x		5110-40300
	Underdel		x		5110-40301

## Marsk Stig, Culti/Avanti

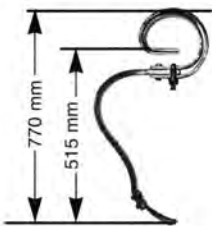

### Stubkultivatortænder

Pos.	Tekst	Original	Uoriginal	Mont. m/spids Grp.-varenummer	Grp.-varenummer
	Tand kpl.	x		5130-01010064	5130-01010092

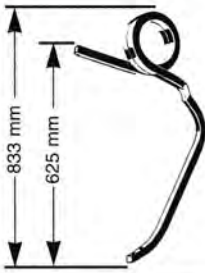

### Stubkultivatortænder

Pos.	Tekst	Original	Uoriginal	Mont. m/spids Grp.-varenummer	Grp.-varenummer
	Stubtand, 30 x 30 mm, u/spids		x		<b>5110-4001</b>

### Agrodan

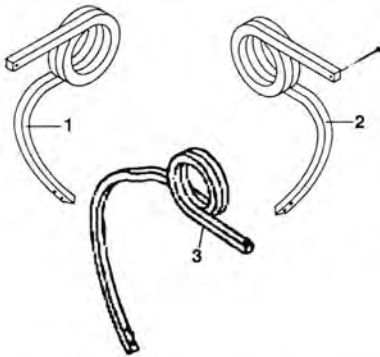

### Stubkultivatortænder

Pos.	Benævnelse	Original	Uoriginal	Anv. på pos.	Pk/bdt.str. eller løse	Grp.-varenummer
1	Tand, forr. venstre u/spids	x			løs	<b>5132-100551</b>
2	Tand, forr. højre u/spids	x			løs	<b>5132-100553</b>
3	Stubtand - Vaks	x			løs	<b>5132-1005159</b>

Vingskær kan ikke anvendes på ovennævnte tænder!

### JOS, Harsø, KAG m.fl.

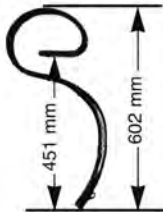

### Stubkultivatortænder

Pos.	Tekst	Original	Uoriginal	Spids t/do. Grp.-varenummer	Grp.-varenummer
	Harvetand, 65 x 10 mm, u/spids Anv. bl.a. som gyllenedfælder		x	5140-10-137	<b>5110-1085</b>





Pos. 1



Pos. 2



Pos. 3



Pos. 4



Pos. 5



Pos. 6

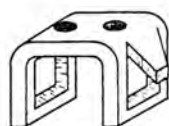

Pos.7 & 8



Pos. 9

Pos.	Mål tand	Mål bulle	Bemærkninger	Grp.-varenummer
1	20 x 6,5 mm	35 x 12 mm	T/5115-1014	<b>5115-10-140</b>
1	25 x 8 mm	40 x 10 mm	T/5115-26-22900 og 5115-1017	<b>5115-10-220</b>
1	45 x 12 mm	50 x 50 mm	5110-1061	<b>5110-45125050</b>
1	32 x 12 mm	50 x 50 mm		<b>5110-432125050</b>
2	32 x 10 mm	50 x 12,5 mm	T/alm. S-tand	<b>5110-10-004</b>
2	32 x 12 mm	50 x 12,5 mm	T/alm. S-tand	<b>5110-10-006</b>
2	32 x 10 mm		T/5115-0422000 og 5115-0422100	<b>5115-1033460</b>
2	32 x 12 mm		T/5115-0422120	<b>5115-1033470</b>
3	32 x 12 mm	50 x 30 mm	T/alm. S-tand	<b>5110-10-047</b>
3	32 x 12 mm	50 x 50 mm	T/alm. S-tand	<b>5110-10-048</b>
3	45 x 10 mm	50 x 50 mm	T/5110-300500	<b>5110-10-059</b>
3	45 x 10 mm	50 x 50 mm	T/5110-201470	<b>5110-400528</b>
4	32 x 10 mm		T/5110-103009 og 5110-103012	<b>5110-103013</b>
5	32 x 10 mm		T/Kongskilde S-tand og Germinator	<b>5125-01000507</b>
5	32 x 12 mm		T/Kongskilde Super-Q og Vibro-Corn	<b>5125-01000742</b>
6	25 x 8 mm	32 x 16 mm	T/5115-0421500	<b>5115-1012800</b>
7	27 x 18 mm		T/Marsk Stig, model 3	<b>5130-01010102</b>
8	26 x 20 mm		T/Marsk Stig, model 4	<b>5130-01010101</b>
9	32 x 10 mm		T/Marsk Stig, model 7	<b>5130-01010107</b>
			Ekcentribolt t/gl. spæn- destykke, ej illustreret	<b>6040-201120</b>

Til diverse harver og plove

3.084

Til endenav

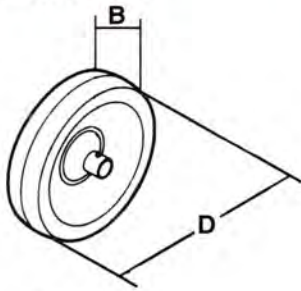

Til gaffel

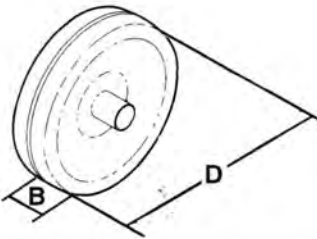
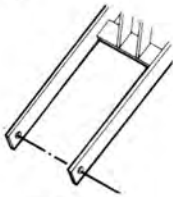

B mm	D mm	Aksel bolt	Gaffel	Endenav	M/aksel	U/aksel	Sæt	Løs	Anvendes på	Grp.-varenummer
140	460	M30		x	x			x	Kverneland	5041-060458
140	460	5/8 UNF		x		x		x	Kongskilde	5100-90063107
75	400	M20		x	x			x	Gl. harver	5112-400
95	395	M16	x		x		x		Kongskilde	5125-01050000
100	430	M16	x		x		x		Kongskilde	5125-01050348
100	430	Ø17	x		x			x	Kongskilde	5125-01050259
75	395	M20		x	x			x	Kongskilde	5125-01020059
95	395	Ø17	x			x		x	Kongskilde	5125-01050258
100	320	M25		x	x			x	Marsk Stig	5130-90040076
140	460	M20		x	x			x	Marsk Stig	5130-90040078
95	395	M25		x		x		x	Howard	5190-1058307
80	280	Ø30	x			x		x	J F	5590-1325-1301
100	280	Ø17	x			x		x	J F	5590-1325-1302
140	280								J F	5590-1325-2303