

BONDIOLI & PAVESI



Indholdsfortegnelse Bypy

Aksler	halvparter	4.080	Gafler	til kryds	4.057
	kpl.	4.079		til Taarup	4.067 & 75
	til Taarup	4.075		til beskyttelsesrør . .	4.076
	til Hesston	4.080		til Bredal	4.067
	vidvinkel	4.081		til fejekoste	4.067
Beskyttelsesrør	halvparter	4.077	til vidvinkel	4.075	
	med lejerings & kæde	4.076			
Koblinger	Bolt	4.067	Kryds		
	Friløb-/friktion . .	4.072 & 73	Krydsliste 4.002	
	Friktion	4.032	Lejeringe 4.077	
	Friktionsplade . . .	4.074	Momentindstillinger 4.070, 71 & 72	
	Sikkerhed	4.069	Profilrør 4.056	
	Stiffriløb	4.068	Rørbeskyttelser 4.076 & 77	
			Tragte	til beskyttelsesrør . .	4.078

Profilrør



NB: Ved bestilling - husk antal m!
eks. 3) 4200-125021000 - der leveres en lgd. á 3 m

Aksel	Kryds	Indvendig profilrør	Udvendig profilrør		Side
1	41201	4200-125021000	4200-125031000		4.057
2	41202	4200-125041000	4200-125051000		4.058
3	41203	4200-125051000	4200-125081000		4.059
4	41204	4200-125071000 4200-245100870 (*)	4200-125081000 4200-125161000 (#)		4.060
5	41205	4200-125091000	4200-125101000		4.062
6	41206	4200-125091000 4200-245160800 (*)	4200-125121000 4200-125171000 (#)		4.063
7	41207	4200-125111000	4200-125121000		4.065
8	41208	4200-125121000	4200-125221000		4.066

(*) = teflonbelagt t/vidvinkel, aksel 4, 870 mm (#) = overstørrelse profilrør t/teflonbelagt

(*) = teflonbelagt t/vidvinkel, aksel 6, 800 mm (#) = overstørrelse profilrør t/teflonbelagt

Akselstørrelse 1

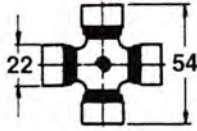

Kryds: 4200-41201

	<p>4200-507010351</p>	<p>Notgaffler Notgaffel, 1 3/8" - 6 noter & snaplås</p>
	<p>4200-204016851 4200-204016852</p>	<p>Gaffler til profilrør Gaffel t/udv. profilrør 12503 Gaffel t/indv. profilrør 12502</p>
	<p>4200-401000001 4200-403000001</p>	<p>Snaplåse Snaplås, kpl. Snaplås, kpl. m/udv. fjeder t/1 3/8" - 6 noter</p>
	<p>4200-239006802 4200-239006803</p>	<p>Lejeringe til profilgaffel, der er påsvejest Lejering t/udv. profilrør 4200-12503 Lejering t/indv. profilrør 4200-12502</p>

Akselstørrelse 2

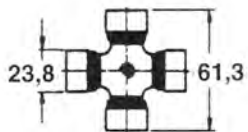

Kryds: 4200-41202

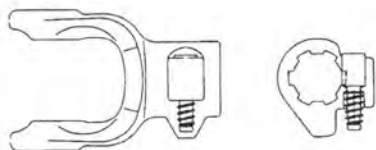

4200-507020151
4200-507020351
4200-507023751

Notgaffler

Notgaffel, 1 1/8" - 6 noter
Notgaffel, 1 3/8" - 6 noter
Notgaffel, 1 3/8" - 21 noter

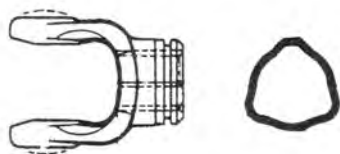

4200-204026851
4200-204026852

Gaffler til profilrør

Gaffel t/udv. profilrør 12505
Gaffel t/indv. profilrør 12504

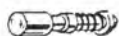

4200-401000001

Snaplåse

Snaplås, kpl.

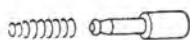

4200-403000001

Snaplås, kpl. m/udv. fjeder t/1 3/8" - 6 noter

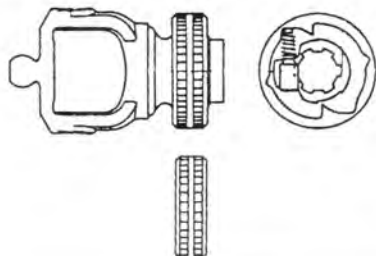

4200-41202
4200-573020351

Kryds & gaffler, vidv. 80 grader

Kryds, standard, 23,8 x 61,3 mm
Notgaffel m/RS-lås 1 3/8" - 6 noter

4200-240080061

Sort plastring 1 3/8", traktorside

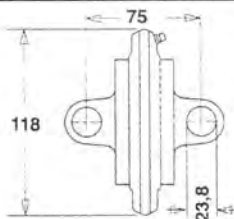

4200-512020051

Mellemstykke, vidvinkel 80 grader

Akselstørrelse 3

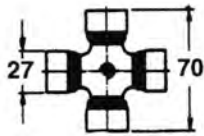

Kryds: 4200-41203

	<p>4200-507030351 4200-507033751</p>	<p>Notgaffler Notgaffel, 1 3/8" - 6 noter & snaplås Notgaffel, 1 3/8" - 21 noter & snaplås</p>
	<p>4200-204036851 4200-204036852</p>	<p>Gaffler til profilrør Gaffel t/udv. profilrør 12508 Gaffel t/indv. profilrør 12505</p>
	<p>4200-211036455</p>	<p>Gaffler med rundt hul Gaffel, Ø 40 mm, 12 mm not</p>
	<p>4200-401000001 4200-403000001</p>	<p>Snaplåse Snaplås, kpl. Snaplås, kpl. m/udv. fjeder t/1 3/8" - 6 noter</p>
	<p>4200-239006814 4200-239006817</p>	<p>Lejeringe til profilgaffel, der er påsvejst Lejering t/udv. profilrør 4200-12508 Lejering t/indv. profilrør 4200-12505</p>



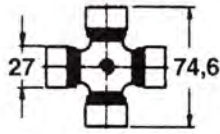

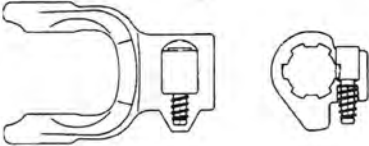
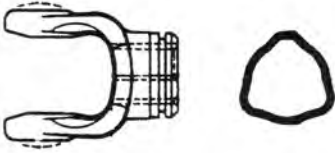
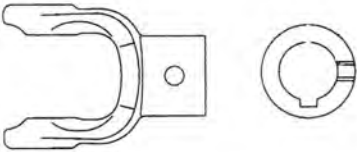
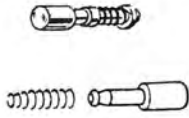
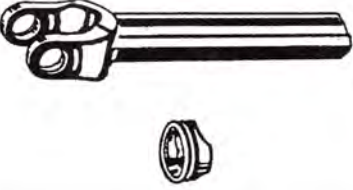

Akselstørrelse 4

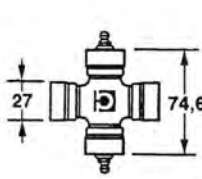
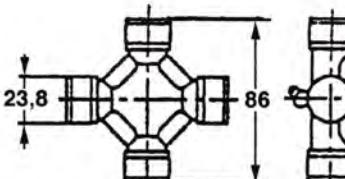

Kryds: 4200-41204

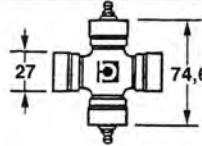
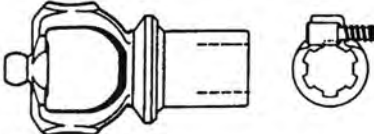
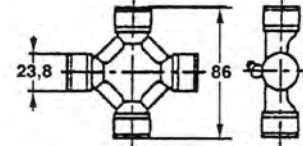
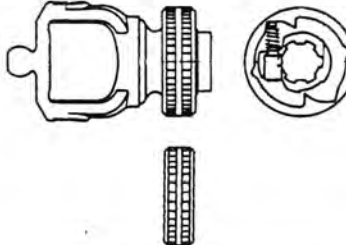
	<p>4200-507040351 4200-507043751</p>	<p>Notgaffler Notgaffel, 1 3/8" - 6 noter m/snåplås Notgaffel, 1 3/8" - 21 noter m/snåplås</p>
	<p>4200-204046851 4200-204046852</p>	<p>Gaffler til profilrør Gaffel t/udv. profilrør 12508 Gaffel t/indv. profilrør 12507</p>
	<p>4200-212046251</p>	<p>Gaffler med rundt hul Gaffel, Ø 30 mm, 8 mm not</p>
	<p>4200-401000001 4200-403000001</p>	<p>Snåplåse Snåplås, kpl. Snåplås, kpl. m/udv. fjeder t/1 3/8" - 6 noter</p>
	<p>4200-239006814 4200-239006817</p>	<p>Lejeringe til profilgaffel, der er påsvejest Lejering t/udv. profilrør 4200-12508 Lejering t/indv. profilrør 4200-12507</p>

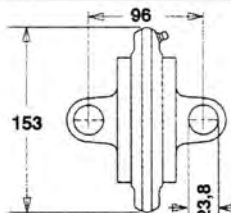
Akselstørrelse 4 - vidvinkel

 <p>70 grader</p>	 <p>80 grader</p>	
 	<p>4200-412040004</p> <p>4200-218040357 4200-218046856</p>	<p>Kryds & gafler, vidvinkel 70 grader Specialkryds, 27 x 74,6 mm</p> <p>Notgaffel 1 3/8" - 6 noter m/snaplås Gaffel t/udv. profilrør</p>
 	<p>4200-412040012</p> <p>4200-573040375 4200-573043775 4200-573043875</p> <p>4200-240080061</p>	<p>Kryds & gafler, vidvinkel 80 grader Specialkryds, 23,8 x 86 mm</p> <p>Notgaffel 1 3/8" - 6 noter m/RS-lås Notgaffel 1 3/8" - 21 noter m/RS-lås Notgaffel 1 3/4" - 20 noter m/RS-lås</p> <p>Sort plastring 1 3/8", traktorside</p>
	<p>4200-215046854</p>	<p>Gafler til profilrør, vidvinkel 80 grader Gaffel t/udv. profilrør</p>
	<p>4200-511040051</p>	<p>Mellemstykke, vidvinkel 80 grader</p>
	<p>4200-245100870 4200-125161000</p>	<p>Profilrør, vidvinkel Indv. profilrør 870 mm teflon Udv. profilrør overstørrelse (3 meter)</p>

Akselstørrelse 5

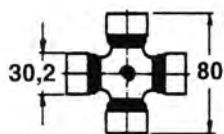

Kryds: 4200-41205

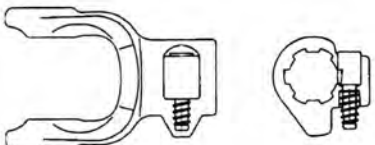
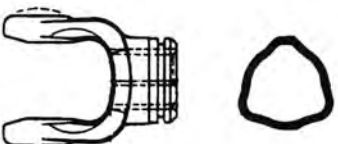
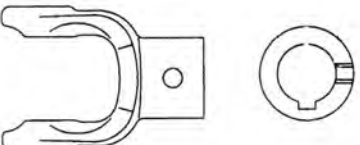
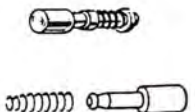
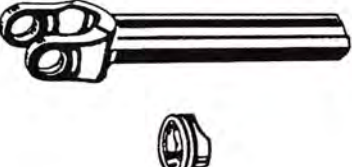
	<p>4200-507050351 4200-507053751 4200-507050451</p>	<p>Notgaffler Notgaffel, 1 3/8" - 6 noter & snaplås Notgaffel, 1 3/8" - 21 noter & snaplås Notgaffel, 1 3/4" - 6 noter & snaplås</p>
	<p>4200-204056860 4200-204056861</p>	<p>Gaffler til profilrør Gaffel t/udv. profilrør 12510 Gaffel t/indv. profilrør 12509</p>
	<p>4200-211055051 4200-212056451</p>	<p>Gaffler med rundt hul Gaffel, Ø 40 mm, 13 mm stifthul (t/Samson) Gaffel, Ø 40 mm, 12 mm not & 12 mm stopskruer</p>
	<p>4200-401000001 4200-403000001</p>	<p>Snaplåse Snaplås, kpl. Snaplås, kpl. m/udv. fjeder t/1 3/8" - 6 noter</p>
	<p>4200-239006818 4200-239006819</p>	<p>Lejeringe til profilgaffel, der er påsvejst Lejering t/udv. profilrør 4200-12510 Lejering t/indv. profilrør 4200-12509</p>



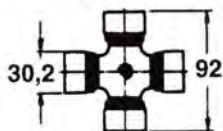



Akselstørrelse 6

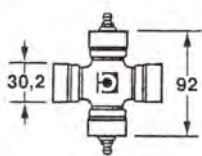
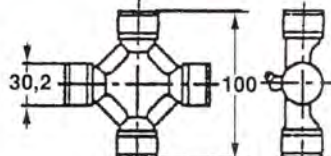
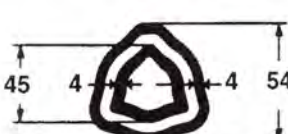
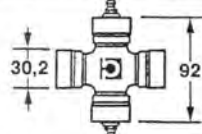
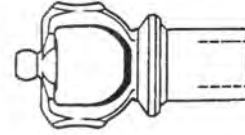
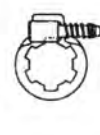
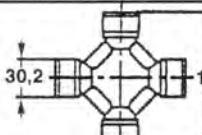
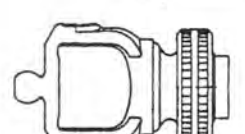

Kryds: 4200-41206

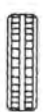
	<p>4200-507060351 4200-507063751 4200-507060451 4200-203060451</p> <p>4200-509060361</p>	<p>Notgaffler Notgaffel, 1 3/8" - 6 noter m/snaplås Notgaffel, 1 3/8" - 21 noter m/snaplås Notgaffel, 1 3/4" - 6 noter m/snaplås Notgaffel, 1 3/4" - 6 noter u/snaplås</p> <p>Notgaffel, 1 3/8" - 6 noter & klembolt</p>
	<p>4200-204066851 4200-204066852</p>	<p>Gaffler til profilrør Gaffel t/udv. profilrør 12512 Gaffel t/indv. profilrør 12509</p>
	<p>4200-213060053</p>	<p>Dobbeltgaffler Dobbeltgaffel</p>
	<p>4200-212066457</p> <p>4200-509066352</p>	<p>Gaffler med rundt hul Gaffel, Ø 40 mm, 12 mm not</p> <p>Gaffel, Ø 35 mm, 10 mm not & klembolt</p>
	<p>4200-401000001</p> <p>4200-403000001</p>	<p>Snaplåse Snaplås, kpl.</p> <p>Snaplås, kpl. m/udv. fjeder t/1 3/8" - 6 noter</p>
	<p>4200-508065359</p>	<p>Svinghjulsgaffel til Hesston Flangegaffel a) 79,20 mm b) t/1/2" stift</p>

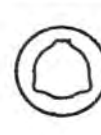
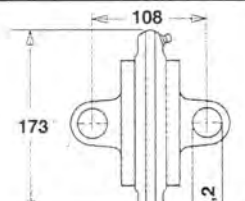
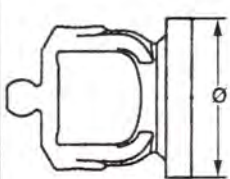
Akselstørrelse 6 - vidvinkel

 <p>70 grader</p>	 <p>80 grader</p>	
  	<p>4200-412060004</p> <p>4200-218060357 4200-519063758</p> <p>4200-218066856 4200-218066857</p>	<p>Kryds & gafler, vidvinkel 70 grader Specialkryds, 30,2 x 92 mm</p> <p>Notgaffel 1 3/8" - 6 noter m/snoplås Notgaffel 1 3/8" - 21 noter m/snoplås</p> <p>Gaffel t/udv. profilrør Gaffel t/indv. profilrør</p>
   	<p>4200-412060012</p> <p>4200-573060375 4200-573063775 4200-573060475 4200-573063875</p> <p>4200-511060315 4200-511063708 4200-511063804</p> <p>4200-240080061</p>	<p>Kryds & gafler, vidvinkel 80 grader Specialkryds, 30,2 x 100 mm</p> <p>Notgaffel 1 3/8" - 6 noter m/RS-lås Notgaffel 1 3/8" - 21 noter m/RS-lås Notgaffel 1 3/4" - 6 noter m/RS-lås Notgaffel 1 3/4" - 20 noter m/RS-lås</p> <p>Notgaffel 1 3/8" - 6 noter m/klombolt (84036361 - NH) Notgaffel 1 3/8" - 21 noter m/klombolt (84036360 - NH) Notgaffel 1 3/4" - 20 noter m/klombolt (84037524 - NH)</p> <p>Sort plastring 1 3/8", traktorside</p>
 	<p>4200-215066854 4200-215066853</p>	<p>Gafler til profilrør, vidvinkel 80 grader Gaffel t/udv. profilrør Gaffel t/indv. profilrør</p> <p>Profilrør til vidvinkel, se side 4.056!</p>
	<p>4200-511060051</p>	<p>Mellemstykke, vidvinkel 80 grader</p>
 	<p>4200-215067251</p>	<p>Flangegaffel til Kuhn, vidvinkel 80 grader</p> <p>Ø = 130 mm, boltecirklen 115 mm 6 stk. 10 mm boltehuller Flangen er med udskæring mellem boltehuller</p>

Akselstørrelse 7 (Ny model)

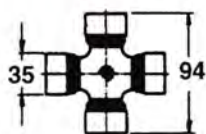

Kryds: 4200-41207

	<p>4200-572070351 4200-507173751 4200-509173751</p>	<p>Notgaffler Notgaffel, 1 3/8" - 6 noter & snaplås Notgaffel, 1 3/8" - 21 noter & snaplås Notgaffel, 1 3/8" - 21 noter m/klømbolt (Taarup 99242247)</p>
	<p>4200-204176851 4200-204176852</p>	<p>Gaffler til profilrør Gaffel t/udv. profilrør 12512 Gaffel t/indv. profilrør 12511</p>
	<p>4200-509176352</p>	<p>Gaffler med rundt hul Gaffel, Ø 35 mm, 10 mm not m/klømbolt (Taarup 99242249)</p>
	<p>4200-403000010 4200-403000001</p>	<p>Snaplåse Snaplås, kpl. t/ 1 3/8" - 21 noter Snaplås, kpl. m/udv. fjeder t/1 3/8" - 6 noter</p>

Akselstørrelse 7 (gammel type)

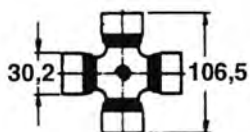

Kryds: 4200-412070001

	<p>4200-507070351 4200-507073701</p>	<p>Notgaffler Notgaffel, 1 3/8" - 6 noter & snaplås Notgaffel, 1 3/8" - 21 noter & snaplås</p>
--	------------------------------------------	-----------------------------------------------------------------------------------------------------------------------

Akselstørrelse 8

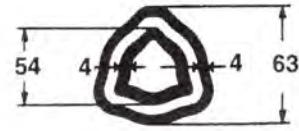
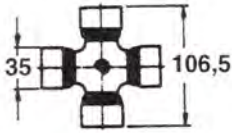

Kryds: 4200-41208

	<p>4200-507080351 4200-507083751 4200-507080481 4200-507083851</p> <p>4200-509083751 4200-509083854</p> <p>4200-408000061</p>	<p>Notgaffler Notgaffel, 1 3/8" - 6 noter m/snoplås Notgaffel, 1 3/8" - 21 noter m/snoplås Notgaffel, 1 3/4" - 6 noter m/snoplås Notgaffel, 1 3/4" - 20 noter m/snoplås</p> <p>Notgaffel, 1 3/8" - 21 noter & klembolt Notgaffel, 1 3/4" - 20 noter & klembolt</p> <p>Kilebolt til 1 3/4" - 6 & 20 noter</p>
	<p>4200-204086860 4200-204086861</p>	<p>Gaffler til profilrør Gaffel t/udv. profilrør 12522 Gaffel t/indv. profilrør 12512</p>
	<p>4200-412080012</p> <p>4200-573080375 4200-573083775 4200-573083875</p> <p>4200-511083706 4200-511083801</p> <p>4200-240080061</p>	<p>Kryds & gaffler t/vidvinkel 80 grader Specialkryds, 35 x 106,5 mm</p> <p>Notgaffel 1 3/8" - 6 noter m/RS-lås Notgaffel 1 3/8" - 21 noter m/RS-lås Notgaffel 1 3/4" - 20 noter m/RS-lås</p> <p>Notgaffel 1 3/8" - 21 noter m/klembolt Notgaffel 1 3/4" - 20 noter m/klembolt</p> <p>Sort plastring 1 3/8", traktorside</p>
	<p>4200-215086854</p>	<p>Gaffler til profilrør, vidvinkel 80 grader Gaffel t/udv. profilrør</p>
	<p>4200-511080051</p>	<p>Mellemstykke, vidvinkel 80 grader</p>
	<p>4200-401000001</p> <p>4200-403000001 4200-403000009</p>	<p>Snoplåse Snoplås, kpl.</p> <p>Snaplås, kpl. m/udv. fjeder t/1 3/8" - 6 noter Snaplås, kpl. m/udv. fjeder t/1 3/8" - 21 noter</p>

Boltkobling, type SB



Grp.-varenummer	Akselstr.	Kpm
4200-606202001	2	90
4200-606303001	3	130
4200-606404001	4	170
4200-606505001	5	210
4200-606606001	6	250

Gaffel t/Taarup



Grp. - varenr.	Benævnelse
4200-213060004	Gaffel t/641 kryds (Taarup 99241703)

Kardanled til fejekoste



Grp. - varenr.	Benævnelse
4200-700349071071	Kardanled, Ø25 x Ø25 med 8 mm stifthul, totallængde 130 mm til kryds 18 x 47 mm

Kardanled t/Bredal



Grp. - varenr.	Benævnelse
4200-81G4000026	Kardanled med friløb, Ø35 x 35 mm

Stiftfriløb RA

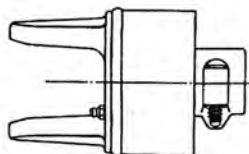

Aksel-str.	Kpl. stiftfriløb	RA 1 Højre/venstre	RA 2 Højre/venstre	Koblingshus	Kryds
3	4200-601103001	H			4200-41203
4	4200-601104001	H		4200-418041120	4200-41204
4	4200-602104001	V			4200-41204
5	4200-601105001	H		4200-418051120	4200-41205
5			H	4200-418052120	4200-41205
6	4200-601206201 Se 1)		H	4200-418062120	4200-41206
6	4200-601206002 Se 2)		H	4200-418062120	4200-41206

1) 1 3/8" med klembolt

2) 1 3/8" - 21

Reserve dele

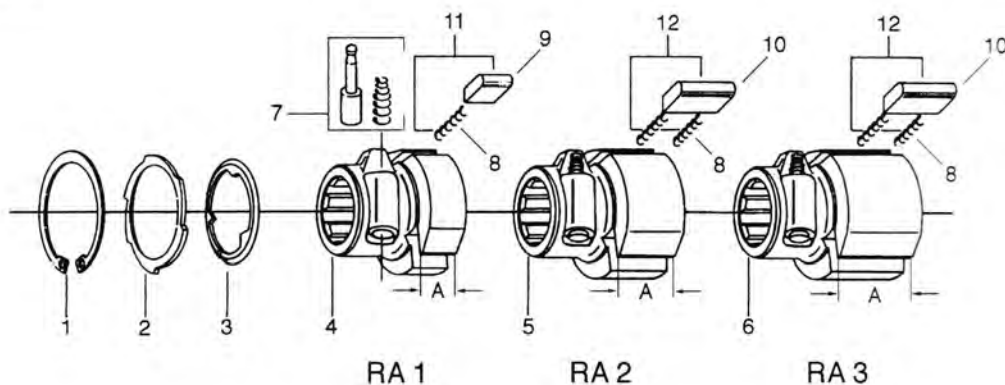

Pos.	Grp. - varenr.	Benævnelse	RA 1	RA 2	RA 3
1	4200-338005000	Låsering	1	1	1
2	4200-246000010	Medbringerskive	1	1	1
3	4200-246000005	Plastring	1	1	1
4	4200-513010302	Nav, 1 3/8" - 6, A = 22 mm	1		
4	4200-513013701	Nav, 1 3/8" - 21, A = 22 mm	1		
5	4200-515020305	Nav til klembolt, 1 3/8" - 6, A = 42 mm		1	
5	4200-515023705	Nav til klembolt, 1 3/8" - 21, A = 42 mm		1	
6	4200-513460301	Nav, 1 3/8" - 6, A = 63 mm			1
6	4200-513463701	Nav, 1 3/8" - 21, A = 63 mm			1
7	4200-403000001	Snaplås, kpl.	1	1	1
8	4200-351010370	Palfjeder	3	6	6
9	4200-250000001	Pal, bredde = 22 mm	3		
10	4200-250000047	Pal, bredde = 42 mm		3	
11	4200-421011101	Palsæt	3		
12	4200-421022101	Palsæt		3	

Sikkerhedskobling, type SA

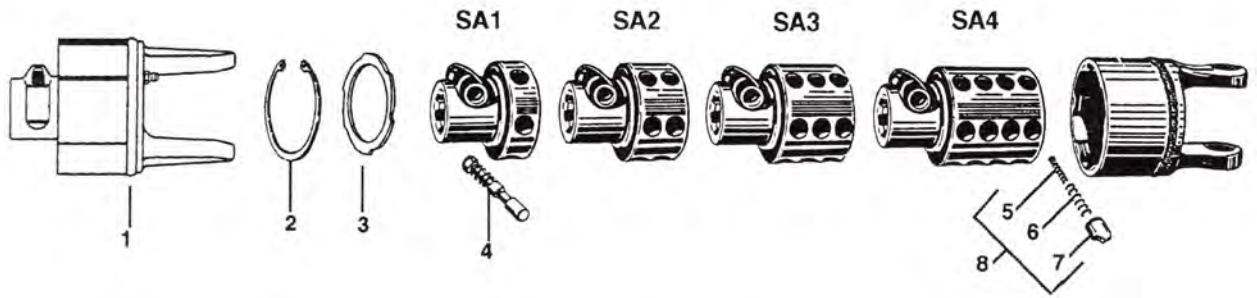

Pos.	Grp.-varenummer	Benævnelse	Aksel-str.	SA1	SA2	SA3	SA4	Moment-indstilling
1	4200-611239001	Kobling kpl., SA 2/2	2		1			80 kg
1	4200-612348001	Kobling kpl., SA 3/3	3			1		120 kg
1	4200-613348001	Kobling kpl., SA 3/4	4			1		120 kg
1	4200-615456001	Kobling kpl., SA 4/6	6				1	160 kg
2	4200-338005000	Låsering		1	1	1	1	
3	4200-240000033	Spændeskive		1	1	1	1	
4	4200-403000001	Snaplås kpl., 47 mm		1	1	1	1	
4	4200-401000006	Snaplås kpl. m/møtrik, totallg. 79,5 mm, gl. model		1	1	1	1	
5	4200-351008901	Fjeder, indv. (evt.)		6	12	18	24	
6	4200-351006901	Fjeder, udv., 2,4 mm (evt.)		5	9	14	19	
6	4200-351007901	Fjeder, udv., 2,2 mm (evt.)		1	3	4	5	
7	4200-250000018	Pal		6	12	18	24	
8	4200-421340001	Palsæt (pos. 5, 6 & 7)		6	12	18	24	

Friktionskobling, type FD2 & FD3

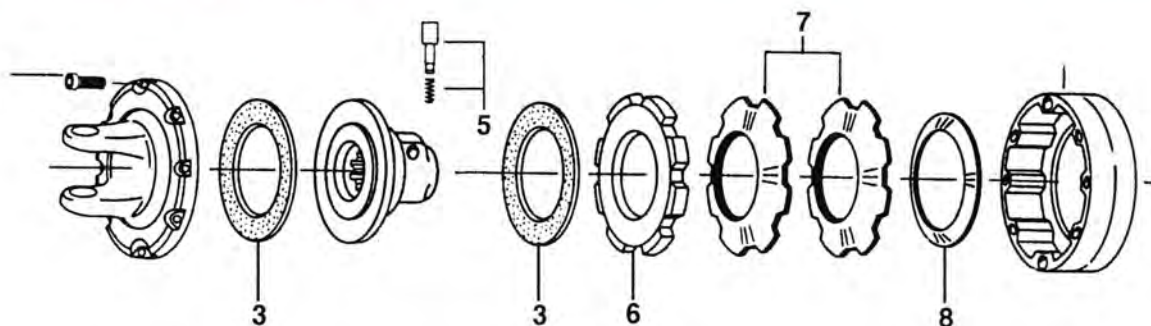

Pos.	Grp.-varenummer	Benævnelse	FD2	FD3
3	4200-247006251	Belægning, Ø142 mm	2	
3	4200-247006351	Belægning, Ø162 mm		2
5	4200-403000009	Snaplås, kpl.	1	1
6	4200-248620001	Tætningsplade	1	
7	4200-367005620	Tallerkenfjeder, 2,5 mm	1	
7	4200-367003620	Tallerkenfjeder, 3,0 mm	1	
7	4200-367001620	Tallerkenfjeder, 3,5 mm	1	
7	4200-367002630	Tallerkenfjeder, 3,5 mm		1
7	4200-367001630	Tallerkenfjeder, 4,0 mm		1
8	4200-246000018	Skive	1	

Momentindstilling af FD2 & FD3



Type	Moment	Antal & tykkelse	Grp. - varenummer
FD2	800 Nm	1 x 2,5 mm	4200-367005620
		1 x 3,0 mm	4200-367003620
	900 Nm	* 1 x 3,0 mm	4200-367004620
		1 x 3,5 mm	4200-367001620
	1000 Nm	1 x 3,0 mm	4200-367003620
1 x 3,5 mm		4200-367001620	
1100 Nm	2 x 3,5 mm	4200-367001620	
	FD3	1200 Nm	2 x 3,5 mm
1450 Nm	1 x 3,5 mm	4200-367002630	
	1 x 4,0 mm	4200-367001630	

* Bemærk! Indvendig diameter 79 mm, de øvrige har indv. mål 75 mm

Kobling, kpl. type FD22 & FD33

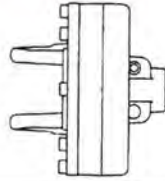

Grp.-varenummer	Benævnelse	Aksel-str.	FD22	FD33
4200-677653703	Kobling, kpl., 1450 Nm	6	1	

Friktionskobling, type FD22 & FD33

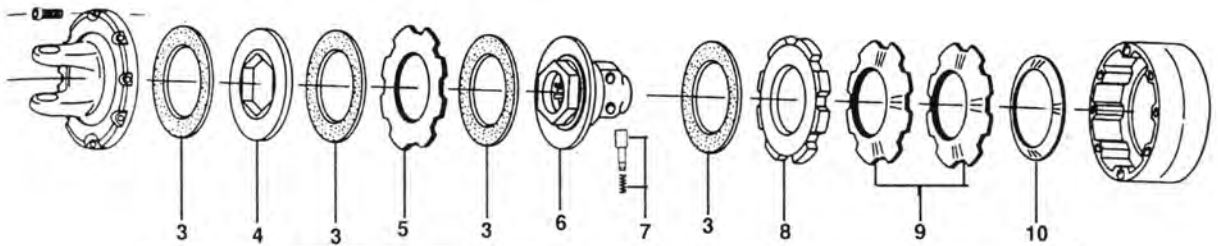

Pos.	Grp.-varenummer	Benævnelse	FD22	FD33
3	4200-247006251	Belægning, Ø142 mm	4	
3	4200-247006351	Belægning, Ø162 mm		4
4	4200-248727701	Medbringerskive	1	
5	4200-248720001	Plade	1	
6	4200-513720301	Nav 1 3/8" - 6	1	
7	4200-403000009	Kpl. snaplås til 1 3/8" nav	1	1
8	4200-248620001	Tætningsplade	1	
9	4200-367005620	Tallerkenfjeder, 2,5 mm	1	
9	4200-367003620	Tallerkenfjeder, 3,0 mm	1	
9	4200-367001620	Tallerkenfjeder, 3,5 mm	1	
9	4200-367002630	Tallerkenfjeder, 3,5 mm		1
9	4200-367001630	Tallerkenfjeder, 4,0 mm		1
10	4200-246000018	Skive	1	

Momentindstilling af FD22 & FD33



Type	Moment	Antal & tykkelse	Grp. - varenummer
FD22	1200 Nm	2 x 2,5 mm	4200-367005620
	1400 Nm	2 x 3,0 mm	4200-367003620
	1700 Nm	1 x 3,0 mm	4200-367003620
		1 x 3,5 mm	4200-367001620
	1800 Nm	2 x 3,5 mm	4200-367001620
FD33	2100 Nm	2 x 3,5 mm	4200-367002630
	2400 Nm	1 x 3,5 mm	4200-367002630
		1 x 4,0 mm	4200-367001630

Kobling, kpl. type FN22 & FN33

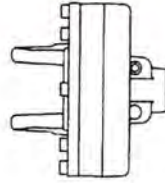

Grp.-varenummer	Benævnelse	Aksel-str.	FN22	FN33
4200-687653703	Kobling, kpl., 1200 Nm	6	1	

Kombineret friløbs-/friktionskobling, type FN22 & FN33

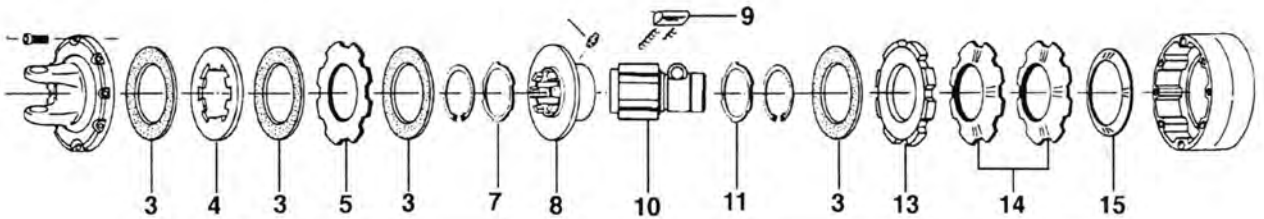

Pos.	Grp.-varenummer	Benævnelse	FN22	FN33
3	4200-247006251	Belægning, Ø142 mm	4	
3	4200-247006351	Belægning, Ø162 mm		4
4	4200-248830001	Medbringerskive	1	
5	4200-248720001	Plade	1	
7	4200-246000024	Ring	1	
8	4200-427220101	Friløbshus	1	
9	4200-421955001	Pal m/2 fjedre	3	3
10	4200-513950301	Friløbsnav 1 3/8" - 6	1	
11	4200-246000025	Ring	1	
13	4200-248620001	Tætningsplade	1	
14	4200-367005620	Tallerkenfjeder, 2,5 mm	1	
14	4200-367003620	Tallerkenfjeder, 3,0 mm	1	
14	4200-367001620	Tallerkenfjeder, 3,5 mm	1	
14	4200-367002630	Tallerkenfjeder, 3,5 mm		1
14	4200-367001630	Tallerkenfjeder, 4,0 mm		1
15	4200-246000018	Skive	1	

Momentindstilling af FN22 & FN33



Type	Moment	Antal & tykkelse	Grp. - varenummer
FN22	1200 Nm	2 x 2,5 mm	4200-367005620
	1400 Nm	2 x 3,0 mm	4200-367003620
	1700 Nm	1 x 3,0 mm	4200-367003620
		1 x 3,5 mm	4200-367001620
FN33	1800 Nm	2 x 3,5 mm	4200-367001620
	2100 Nm	2 x 3,5 mm	4200-367002630
		2400 Nm	1 x 3,5 mm
		1 x 4,0 mm	4200-367001630

Friktionskobling, type FF

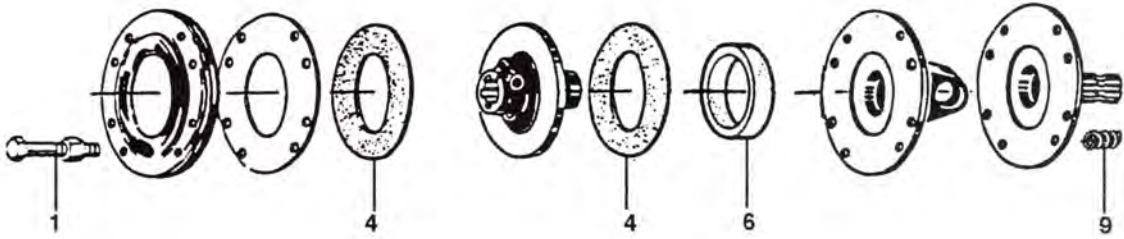

Pos.	Grp.-varenummer	Benævnelse	FF1	FF2	FF3	FF4
1	4200-432000006	Bolt m/møtrik	8	8		
1	4200-432000007	Bolt m/møtrik	8	8	8	8
4	4200-247000054	Friktionsskive, Ø85 x 140 mm	2		4	
4	4200-247000061	Friktionsskive, Ø95 x 160 mm		2		4
6	4200-258005320	Bøsning	1	1	1	1
9	4200-351016370	Fjeder, Ø5 mm	8	8	8	8
9	4200-351022370	Fjeder, Ø6 mm. standard	8	8	8	8
9	4200-351013370	Fjeder, Ø7 mm	8	8	8	8

Kombineret friløbs- & friktionskobling, type FF4/RA2

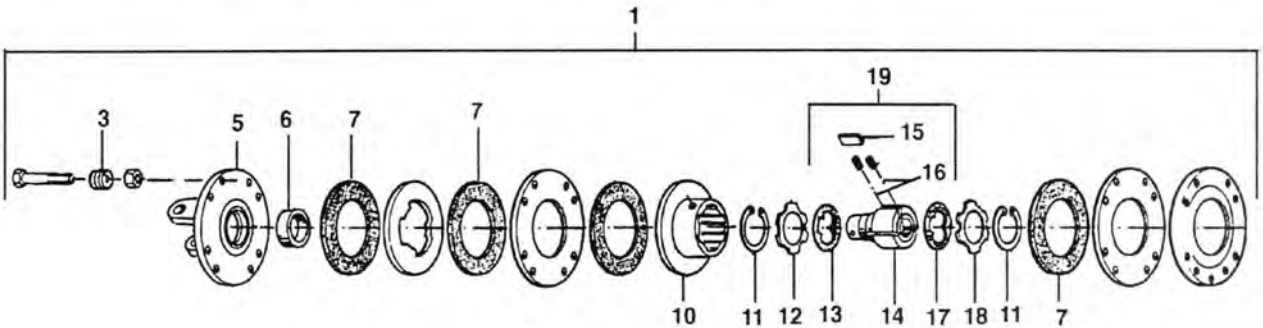

Pos.	Grp.-varenummer	Benævnelse
1	4200-639451003	Kombineret friløbs- & friktionskobling, kpl., t/akselstr. 6
3	4200-351022370	Fjeder
5	4200-253062402	Flangegaffel
6	4200-258005370	Bøsning
7	4200-247000057	Belægning, Ø100 x 160 mm
10	4200-418000102	Medbringerskive
11	4200-338005000	Låsering
12	4200-246000011	Ring
13	4200-246000007	Ring
14	4200-232230301	Nav
15	4200-250000047	Pal
16	4200-351010370	Fjeder
17	4200-246000005	Plastring
18	4200-246000010	Låseskive
19	4200-421022101	Palsæt med 2 fjedre

Friktionspladekobling, type T (erstattes af type FD)

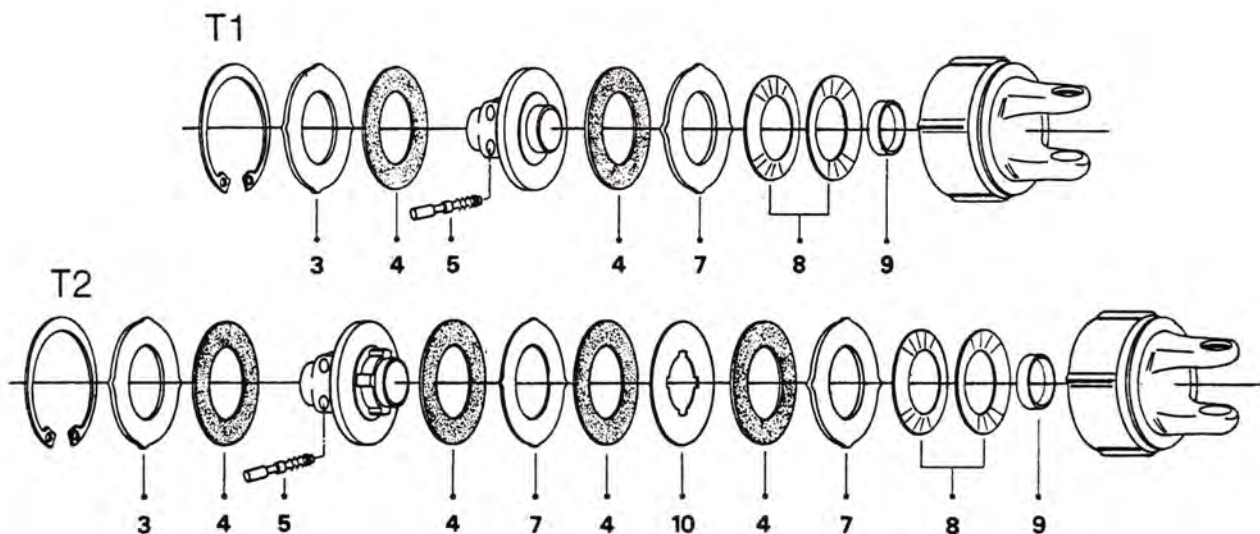

Pos.	Grp.-varenummer	Benævnelse	T1	T2
3	4200-248170002	Trykskive	1	1
4	4200-247000054	Belægning, Ø85 x 146 mm	2	4
5	4200-401000001	Snaplås	2	4
7	4200-248160001	Trykskive, 3,0 mm - udgået	1	1
7	4200-248170001	Trykskive, 5,0 mm - udgået	1	1
8	4200-367005000	Tallerkenskive, 3,8 mm - udgået	1	1
9	4200-258005320	Bøsning	1	1
10	4200-248170005	Medbringerskive		1

Specielle aksler til Taarup 306/307

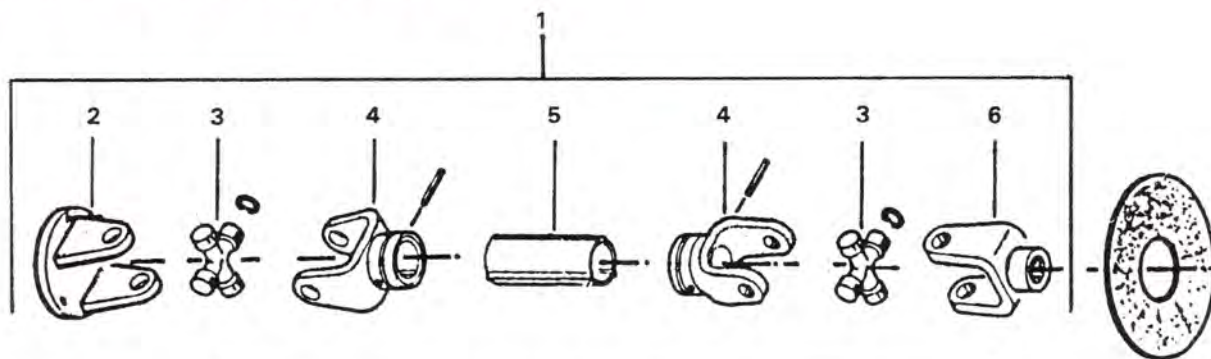

Pos.	Grp.-varenummer	Benævnelse
1	4200-810201800002	Kardanled, kpl.
2	4200-222027351	Flangegaffel
3	4200-411020002	Kryds
4	4200-204026851	Gaffel t/profilrør 203
5	4200-125051000	Profilrør (topmål 29 mm)
6	4200-204023751	Gaffel m/neddrejning

Specielle gafler til Taarup 108

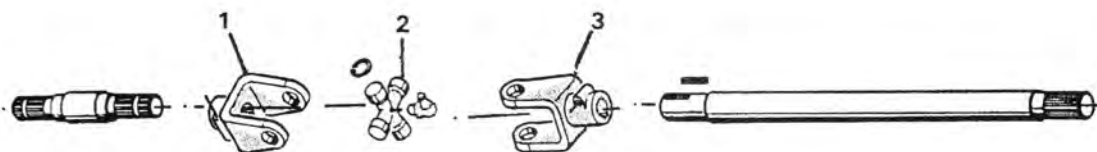

Pos.	Grp.-varenummer	Benævnelse
1	4200-509173751	Gaffel, 1 3/8" - 21 noter m/klombolt (Taarup 99242247)
2	4200-41207	Kryds (Taarup 99242435)
3	4200-509176352	Gaffel, Ø35 mm, 10 mm not m/klombolt (Taarup 99242249)

Kpl. beskyttelsesrør incl. lejerings og holdekæde

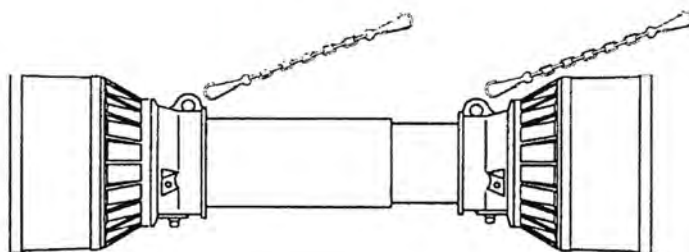

Aksel-str.	Grp.-varenummer	Benævnelse	Rørlængde uden hætte
1	4200-5F01086	Kpl. beskyttelsesrør	700 mm
1	4200-5F01121	Kpl. beskyttelsesrør	1040 mm
2	4200-5F02086	Kpl. beskyttelsesrør	700 mm
2	4200-5F02121	Kpl. beskyttelsesrør	1040 mm
3+4	4200-5F03101	Kpl. beskyttelsesrør	830 mm
3+4	4200-5F03121	Kpl. beskyttelsesrør	1000 mm
5	4200-5F05086	Kpl. beskyttelsesrør	650 mm
5	4200-5F05121	Kpl. beskyttelsesrør	1000 mm
6+7	4200-5F06086	Kpl. beskyttelsesrør	650 mm
6+7	4200-5F06121	Kpl. beskyttelsesrør	1000 mm
8	4200-5F08086	Kpl. beskyttelsesrør	600 mm
8	4200-5F08121	Kpl. beskyttelsesrør	950 mm

De sidste 3 cifre i varenummeret fortæller længden på komplet aksel fra midt kryds til midt kryds

Holdekæde t/beskyttelsesrør



Grp. - varenr.	Benævnelse
4200-252000001	Holdekæde

Halvparter - rørbeskyttelse incl. holdekæde og excl. lejering

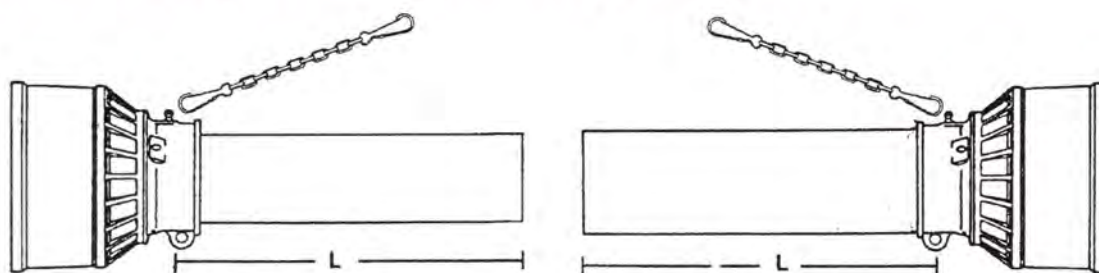

Aksel-str.	Standard/ vidvinkel	Indv. beskyttelses- rør kpl.	Udv. beskyttelses- rør kpl.	Længde uden hætte
1, 2	Standard	4200-5F01086-I	4200-5F01086-U	700 mm
1, 2	Standard	4200-5F01121-I	4200-5F01121-U	1040 mm
3, 4	Standard	4200-5F03101-I	4200-5F03101-U	830 mm
5, 6, 7	Standard	4200-5F05086-I	4200-5F05086-U	650 mm
5, 6, 7	Standard	4200-5F05121-I	4200-5F05121-U	1000 mm
6	Vidvinkel	4200-5F1305086-I		700 mm
6	Vidvinkel		4200-5F3105086-U	700 mm
6	Vidvinkel		4200-5F3106121-U	1000 mm
8, 9, 10	Standard	4200-5F08086-I	4200-5F08086-U	600 mm
8, 9, 10	Standard	4200-5F08121-I	4200-5F08121-U	950 mm

Alle beskyttelsesrør leveres med holdekæde

Lejeringe

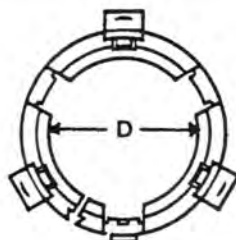

Aksel-str.	Til indvendig beskyttelsesrør	Diameter mm	Til udvendig beskyttelsesrør	Diameter mm
1	4200-255010006	34,4	4200-255010005	40,4
2	4200-255020006	40,4	4200-255020005	47,4
3, 4	4200-255040006	46,4	4200-255040005	53,4
5	4200-255050006	53,4	4200-255050005	62,4
6, 7	4200-255060006	59,4	4200-255060005	68,4
8, 9, 10	4200-255080006	68,4	4200-255080005	80,4
8, 9, 10	4200-255080016	60,0	4200-255080015	68,0

Lejeringe t/beskyttelsesrør (Taarup)

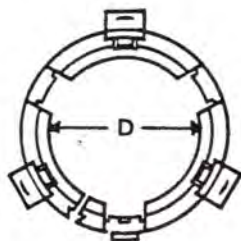

Aksel-str.	Til indvendig beskyttelsesrør monteret på udvendig profilrør	Diameter mm
6	4200-255060009	62,0

Aksel-str.	Til udvendig beskyttelsesrør monteret på indvendig profilrør	Diameter mm
6	4200-255060005	68,4

Tragte til standard beskyttelsesrør, type F

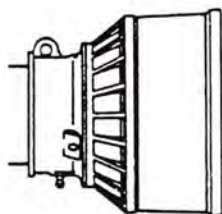

Aksel-str.	Indvendig tragt kpl.	Udvendig tragt kpl.
1, 2	4200-517010020	4200-517010030
3, 4	4200-517040020	4200-517040030
5, 6, 7	4200-517050020	4200-517050030
8, 9	4200-517080120	4200-517080130

Tragte til vidvinkel 70 gr.

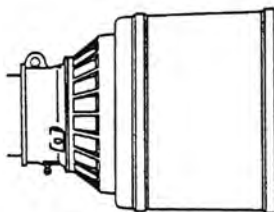

Aksel-str.	Indvendig tragt kpl.	Udvendig tragt kpl.
4	4200-517040023	4200-517040033
6	4200-517050023	4200-517050033
8	4200-517080023	4200-517080033

Tragte til vidvinkel 80 gr.

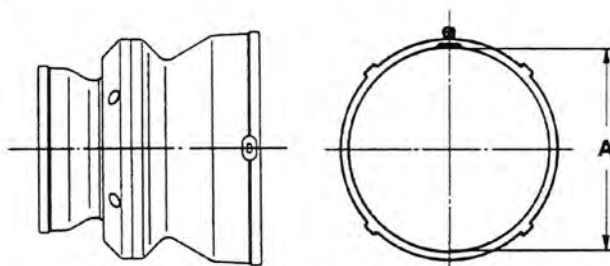

Aksel-str.	Tragt incl. løbering, kpl.	Løbering	A mm
2	4200-517027001		83,4
4	4200-517048001	4200-255040351	105,4
6	4200-517068001	4200-255060351	125,4
8	4200-517088001	4200-255080351	140,4

Komplette kraftoverføringsaksler

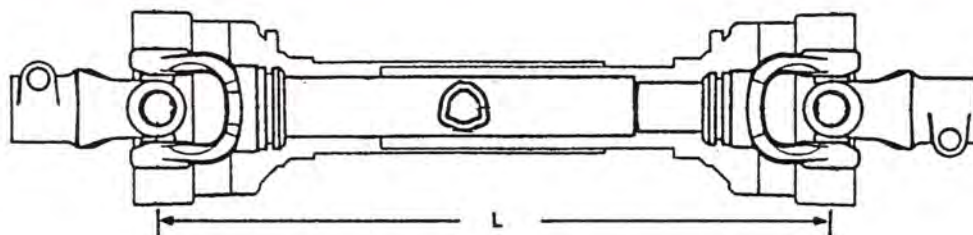

L = sammenskudt længde fra midt kryds til midt kryds

Aksel-str.	Kryds	Konstant ved 540 o/min.		Konstant ved 1000 o/min.	
		Effekt		Effekt	
		Kw	Hk	Kw	Hk
1	41201	12	16	18	25
2	41202	15	21	23	31
3	41203	22	30	35	47
4	41204	26	35	40	55
5	41205	35	47	54	74
6	41206	47	64	74	100
8	41208	70	95	110	150

	Aksel-str.	Længde (L) i mm	Grp.- varenr.	Traktorside	Redskabsside
Bredal	2	810	4210-102081F00707	1 3/8" - 6	1 3/8" - 6
	3	810	4210-103081F00707	1 3/8" - 6	1 3/8" - 6
	3	1010	4210-103101F07096	1 3/8" - 6	RA1 friløb, 1 3/8" - 6
	3	990	4210-103099F07098	1 3/8" - 6	Boltekobling, 1 3/8" - 6
Taarup (99240217)	4	810	4210-104081F00707	1 3/8" - 6	1 3/8" - 6
	4	810	4210-104081F07635	1 3/8" - 6	V. friløb
	4	810	4210-104081F15077	1 3/8" - 6	1 3/8" - 6
	5	603	4210-1R5060F0707	1 3/8" - 6	1 3/8" - 6
	5	603	4210-1R5060F07096	1 3/8" - 6	1 3/8" - 6
Taarup (99240260)	6	810	4210-106081F00707	1 3/8" - 6	1 3/8" - 6
	6	1010	4210-106101F07098	1 3/8" - 6	Boltekobling, 1 3/8" - 6
	6	1510	4210-106151F00707	1 3/8" - 6	1 3/8" - 6
	6	603	4210-1R6060F0707	1 3/8" - 6	1 3/8" - 6
Taarup (99240248)	8	1010	4210-108101F07007	1 3/8" - 6	1 3/8" - 6

Komplette halvparter

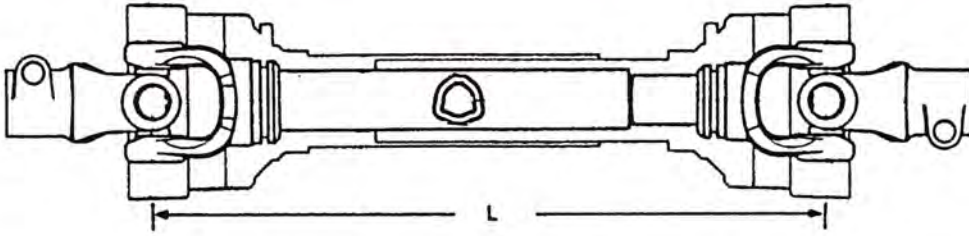

L = sammenskudt længde fra midt kryds til midt kryds

Aksel-str.	Længde (L) i mm	Grp.- varenr.	Traktorside - udvendig	Redskabsside - indvendig
1	860	4210-101086F007-U	1 3/8" - 6	
1	860	4210-101086F007-I		1 3/8" - 6
3	860	4210-103086F007-U	1 3/8" - 6	
3	860	4210-103086F007-I		1 3/8" - 6
3	1010	4210-103101F007-U	1 3/8" - 6	
3	1010	4210-103101F007-I		1 3/8" - 6
4	860	4210-104086F007-U	1 3/8" - 6	
4	860	4210-104086F007-I		1 3/8" - 6
5	860	4210-105086F007-U	1 3/8" - 6	
5	860	4210-105086F007-I		1 3/8" - 6
6	860	4210-106086F007-U	1 3/8" - 6	
6	860	4210-106086F007-I		1 3/8" - 6

Speciel aksel Type 408 Til Hesston 4800 & 4900

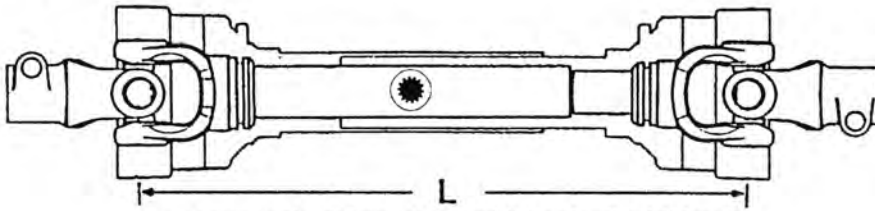

L = sammenskudt længde fra midt kryds til midt kryds

Aksel-str.	Længde (L) i mm	Grp.- varenr.	Traktorside - udvendig	Redskabsside - indvendig
8	550	4210-408051F008-U	1 3/8" - 21	
8	550	4210-408055F017-I		1 3/4" - 20 - klembolt

Komplette kraftoverføringsaksler - vidvinkel

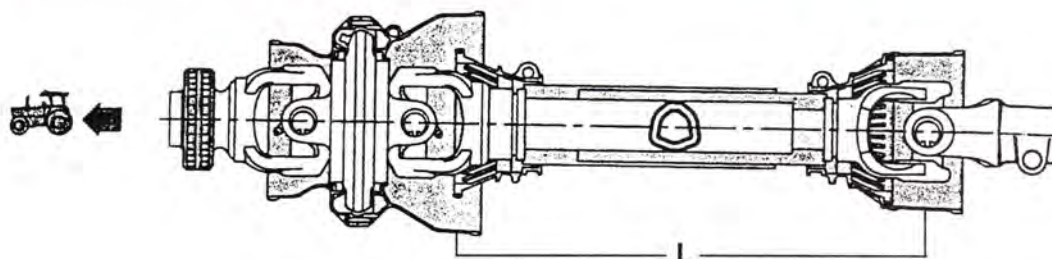

	Kpl. vidvinkel		Vidvinkel på udv. halvpart	Vidvinkel side udvendig	Modpart indvendig
	Akselstr./ grader	Længde (L) i mm			
	2 - 80	410	4210-652041F05307	Ø25 glat	1 3/8" - 6
	2 - 80	710	4210-652071FT0707	1 3/8" - 6	1 3/8" - 6
	4 - 80	1010	4210-654101FT0707	1 3/8" - 6	1 3/8" - 6
	4 - 80	1010	4210-654101FT0798	1 3/8" - 6	Boltekobling, 1 3/8" - 6
* Taarup 307 (99240279)	6 - 80	710	4210-656071FT0707	1 3/8" - 6	1 3/8" - 6
	6 - 80	1010	4210-656101FT0707	1 3/8" - 6	1 3/8" - 6
	6 - 80	1010	4210-656101FT0807	1 3/8" - 21	1 3/8" - 6
* Taarup 338 (99240206)	6 - 80	1060	4210-6106P9563T07	1 3/8" - 6	FN22 kobling, 1200 Nm, 1 3/8" - 6
* Taarup 338 (99240336)	6 - 50	1060	4210-61106FT58307	1 3/8" - 6	FN22 kobling, 1200 Nm, 1 3/8" - 6
Hesston 4700	6 - 80	1210	4210-656121FT0707	1 3/8" - 6	1 3/8" - 6
Hesston 4700	6 - 80	1210	4210-656121FT0807	1 3/8" - 21	1 3/8" - 6
Hesston m/snitte	8 - 80	910	4210-658091FT0709	1 3/8" - 6	1 3/4" - 6
Hesston m/snitte	8 - 80	910	4210-658091FT0809	1 3/8" - 21	1 3/4" - 6
Hesston m/snitte	8 - 80	1210	4210-658121FT0709	1 3/8" - 6	1 3/4" - 6
Hesston m/snitte	8 - 80	1210	4210-658121FT0809	1 3/8" - 21	1 3/4" - 6

* Bemærk! Vidvinkel er monteret på den indvendige halvpart

Komplette halvparter - vidvinkel

	Kpl. vidvinkel		Halvpart	Vidvinkel side udvendig	Modpart indvendig
	Akselstr./ grader	Længde (L) i mm			
	6	1010	4210-656101FT07-I		1 3/8" - 21
	6 - 80	1010	4210-656101FT07-U	1 3/8" - 6	
	6 - 80	1010	4210-656101FT08-U	1 3/8" - 21	

Kryds til vidvinkel - 70 grader

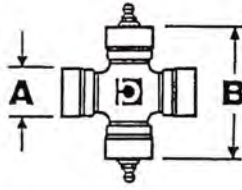
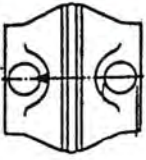

Aksel-str.	Grp.- varenr.	A	B	Bemærkninger
4	4200-412040004	27,0	74,6	Smørenipler i nødder
6	4200-412060004	30,2	92,0	Smørenipler i nødder

Kryds til vidvinkel - 80 grader, gl. model

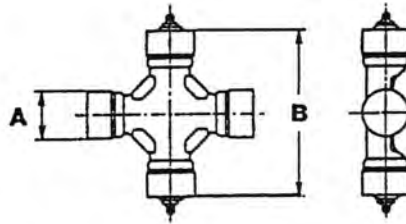
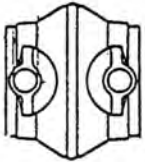

Aksel-str.	Grp.- varenr.	A	B	Bemærkninger
6	4200-412060006	30,2	100,0	Smørenipler i nødder

Kryds til vidvinkel - 80 grader, ny model

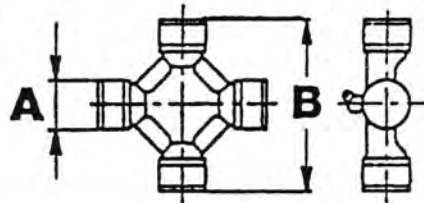
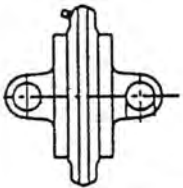

Aksel-str.	Grp.- varenr.	A	B	Bemærkninger
4	4200-412040012	23,8	86,0	Smørenippel i centrum
6	4200-412060012	30,2	100,0	Smørenippel i centrum
8	4200-412080012	35,0	106,0	Smørenippel i centrum