

WALTERSCHEID

Indholdsfortegnelse Walterscheid

Aksler	halvparter4.044	Gafler	til kryds4.006
	kpl.4.043	Krydsliste4.002
	vidvinkel4.045	Momentindstillinger4.034 & 37
Automatisk tilkobling4.038	Profilrør4.004
Beskyttelsesrør	med glidering4.039	Rørbeskyttelser4.039 & 42
Koblinger	Bolt4.027	Stifriløb4.028
	Friløb-/friktion4.036	Svejseringe	til profilrør4.040
	Friktion4.032	Tragte	til beskyttelsesrør ...4.041
	Friløb4.028		
	Sikkerhed4.030		







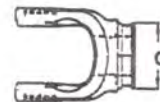
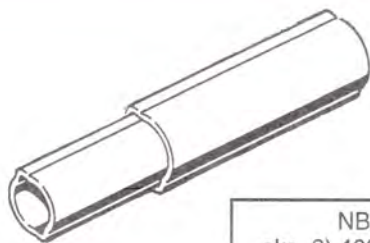



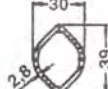

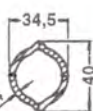
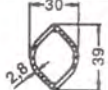
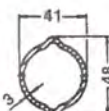

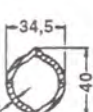
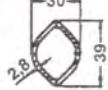
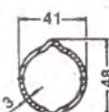

Indholdsfortegnelse Diverse

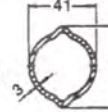
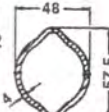
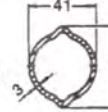
Beskyttelsesskærme4.047	Overgangsbøsninger4.046
Bøsninger	med krave4.046	Profilnav4.047
Forlængerbøsninger4.046	WKS	hurtigkoblingsæt ...4.049
Kryds	diverse4.048	WKS	hydr. topstænger ...4.050
Notaksler4.047	WKS	reservedele ...4.050 - 54
Nottappe4.047		
Nålelejekryds	til Bogense4.048		
	uoriginale4.048		

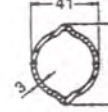
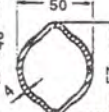
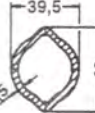
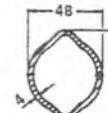
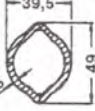
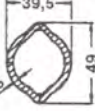
Profilrør

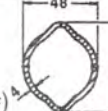

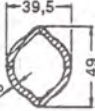
NB: Ved bestilling - husk antal m!
eks. 3) 4000-750600 - der leveres en lgd. á 3 m

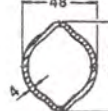
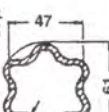
Aksel	Kryds	Indvendig profilrør	Udvendig profilrør	C-mål gaffel
W2000	190000	4000-750600 (OOA) 	4000-751200 (OA) 	47 mm
W100 W2100 W2101	100100	4000-750600 (OOA)  4000-751100 (OV) 	4000-751200 (OA)  4000-751500 (1) 	47 mm 58 mm
W200 W2200	200000	4000-750600 (OOA)  4000-751100 (OV)  4000-751196 (*)	4000-751200 (OA)  4000-751500 (1)  4000-751600 (1) (#)	47 mm 58 mm 58 mm
W210 W2300	210000	4000-751100 (OV)  4000-751196 (*)  4000-752500 (1B) 	4000-751500 (1)  4000-751600 (1) (#)  4000-753500 (2A) 	58 mm 58 mm 70 mm
WI	110300	4000-751100 (OV)  4000-751500 (1) 	4000-751500 (1)  4000-753000 (2) 	58 mm 70 mm
W220	220000	4000-752500 (1B) 	4000-753500 (2A) 	70 mm
W2400 W2400	350000 350000	4000-752500 (1B)  4000-752595 (1B)(*)  4000-754400 (S4) 	4000-753500 (2A)  4000-753600 (2A)(#)  4000-754500 (S5) 	70 mm 70 mm 70 mm
WII	120000	4000-752500 (1B)  4000-754400 (S4) 	4000-753500 (2A)  4000-754500 (S5) 	70 mm 70 mm

(*) = teflonbelagt t/vidinkel, L = 1,2 m
(#) = overstørrelse profilrør t/teflonbelagt

April 1999

Profilrør

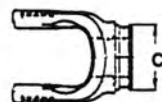
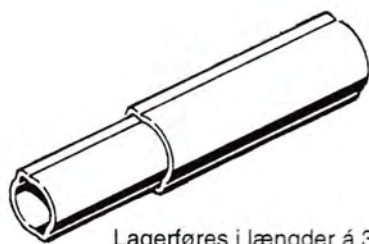

Lagerføres i længder á 3 meter

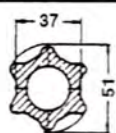
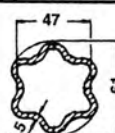
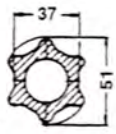
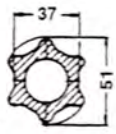
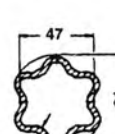
Aksel	Kryds	Indvendig profilrør	Udvendig profilrør	C-mål gaffel
W240	240100	4000-754400 (S4) 	4000-754500 (S5) 	70 mm
W2500	360000	4000-754400 (S4)  4000-754498 (S4-GA)(*) 	4000-754500 (S5) 	70 mm

(*) = teflonbelagt t/vidvinkel, L = 1,2 m

(#) = overstørrelse profilrør t/teflonbelagt

Gafler til kryds 100100, serie W2100

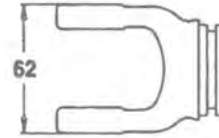
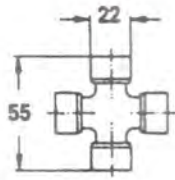

Kryds: 4000-100100

	<p>4000-101100 4000-101000 4000-105000 4000-1011100 4000-1011105</p> <p>4000-1080100</p>	<p>Notgaffler</p> <p>Notgaffel, 1 1/8" 6 noter & snaplås Notgaffel, 1 3/8" 6 noter & snaplås Notgaffel, 1 3/8" 21 noter & snaplås Notgaffel, 21 x 25 mm 6 noter & snaplås Uni 221 Notgaffel, 26 x 30 mm 6 noter & snaplås Uni 226</p> <p>Notgaffel, 22 x 25 mm 10 noter & spærremuffe</p>
	<p>4000-104800 4000-104900 4000-104000 4000-104100</p>	<p>Gaffler til profilrør</p> <p>Gaffel t/indv. rør 750600 Ø23,5 mm Gaffel t/udv. rør 751200 Ø30,0 mm Gaffel t/indv. rør 751100 Ø34,5 mm Gaffel t/udv. rør 751500 Ø41,0 mm</p>
	<p>4000-102227 4000-102229 4000-1022113 4000-102231 4000-1022108 4000-102233 4000-101007</p>	<p>Gaffler med rundt hul</p> <p>Gaffel, 20 mm 6 mm not 8 mm gevindhul Gaffel, 22 mm 6 mm not 10 mm gevindhul Gaffel, 25 mm 8 mm stifthul Gaffel, 25 mm 8 mm not 10 mm gevindhul Gaffel, 30 mm 10 mm stifthul Gaffel, 30 mm 8 mm not 10 mm gevindhul Gaffel, 30 mm 8 mm not & spændebolt</p>
	<p>4000-102800</p>	<p>Dobbeltgaffler</p> <p>Dobbeltgaffel</p>
		<p>fortsættes.....</p>

Gafler til kryds 100100, serie W2100

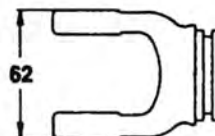
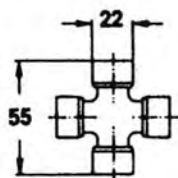

Kryds: 4000-100100

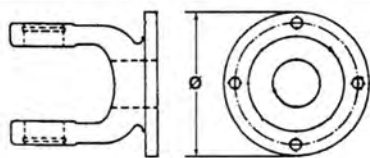

4000-1027100
4000-102702

Flangegafler

Flangegaffel 4 bolthuller Ø87,5 mm
Flangegaffel 4 bolthuller Ø90,0 mm

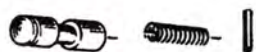

4000-1032101

Flangegaffel m/trekantet flange og 25 mm tap, *Vicon*

4000-650100

Snaplåse

Snaplås, kpl.

agraset®

100



4000-650104

Snaplås, t/21 noter

104

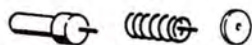

4000-650112

Snaplås, kpl.

101

Gafler til kryds 110300

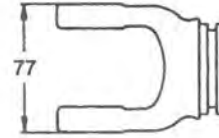
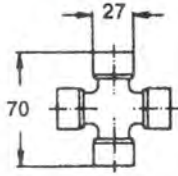

Kryds: 4000-110300

	<p>4000-111100 4000-111000</p>	<p>Notgafler Notgaffel, 1 1/8" 6 noter & snaplås Notgaffel, 1 3/8" 6 noter & snaplås</p>
	<p>4000-113800 4000-115100 4000-113900</p>	<p>Gafler til profilrør Gaffel t/indv. rør 751100 Ø34,5 mm Gaffel t/indv. rør 751100 Ø34,5 mm (m/korte ben) Gaffel t/udv. rør 751500 Ø41,0 mm</p>
	<p>4000-112311 4000-1123112 4000-112333 4000-1155100 4000-112315</p>	<p>Gafler med rundt hul Gaffel, 30 mm 10 mm stifthul Gaffel, 30 mm 11 mm stifthul Gaffel, 30 mm 8 mm not 12 mm gevindhul Gaffel, 35 mm korte ben 12 mm stifthul Gaffel, 35 mm 13 mm stifthul</p>
	<p>4000-112702 4000-112703 4000-112706</p>	<p>Flangegaffler Flangegaffel 4 bolthuller Ø90 mm Flangegaffel 6 bolthuller Ø100 mm (lille konisk hul) Flangegaffel 6 bolthuller Ø100 mm (stort konisk hul)</p>
	<p>4000-650100 4000-650104</p>	<p>Snaplåse agraset® Snaplås, kpl. 100 Snaplås, 1/21 noter 104</p>

Gafler til kryds 120000

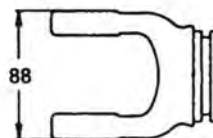
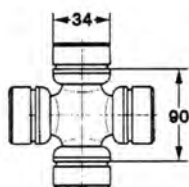

Kryds: 4000-120000

	<p>4000-121000 4000-125000 4000-121300</p>	<p>Notgaffler Notgaffel, 1 3/8" 6 noter & snaplås Notgaffel, 1 3/8" 21 noter & snaplås Notgaffel, 1 3/4" 6 noter & snaplås t/Welger</p>
	<p>4000-123800 4000-123900</p>	<p>Gaffler til profilrør Gaffel t/indv. rør 752500 Ø39,5 mm Gaffel t/udv. rør 753500 Ø48,0 mm</p>
	<p>4000-123802 4000-123000</p>	<p>Gaffler til stjerneør Gaffel t/indv. stjerneaksel 754400 Ø51,0 mm Gaffel t/udv. stjerneør 754500 Ø61,0 mm</p>
	<p>4000-122333 4000-1255100 4000-122435 4000-1224110</p>	<p>Gaffler med rundt hul Gaffel, 30 mm 8 mm not 12 mm gevindhul Gaffel, 35 mm 12 mm stifthul Gaffel, 35 mm 10 mm not 12 mm gevindhul Gaffel, 40 mm 13 mm stifthul</p>
	<p>4000-122703 4000-1227114</p>	<p>Flangegaffler Flangegaffel 6 bolthuller Ø100 mm Flangegaffel 6 bolthuller Ø120 mm (helt flad)</p>
	<p>4000-650100 4000-650104</p>	<p>Snaplåse agraset® Snaplås, kpl. 100 Snaplås, t/21 noter 104</p>

Gafler til kryds 190000

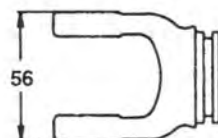
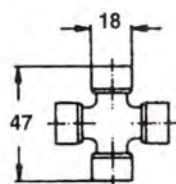

Kryds: 4000-190000

	<p>4000-191000</p>	<p>Notgaffler Notgaffel, 1 3/8" 6 noter & snaplås</p>
	<p>4000-191100 4000-191200</p>	<p>Gaffler til profilrør Gaffel t/indv. rør 750600 Ø23,5 mm Gaffel t/udv. rør 751200 Ø30,0 mm</p>
	<p>4000-191314</p>	<p>Gaffler med rundt hul Gaffel, 20 mm 6 mm not 8 mm gevindhul</p>

Gafler til kryds 200000, serie W2200

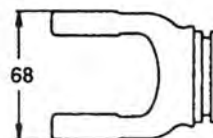
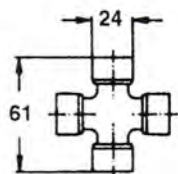

Kryds: 4000-200000

	<p>4000-202700 4000-201000 4000-201800 4000-2038121</p> <p>4000-208300</p>	<p>Notgaffler Notgaffel, 1 1/8" 6 noter & snaplås Notgaffel, 1 3/8" 6 noter & snaplås Notgaffel, 1 3/8" 21 noter & snaplås Notgaffel, 1 3/8" 21 noter 11 mm stifthul t/Vicon</p> <p>Notgaffel, 1 3/8" 6 noter & quicklås</p>
	<p>4000-203200 4000-203300 4000-201100 4000-201200</p>	<p>Gafler til profilrør Gaffel t/indv. rør 750600 Ø23,5 mm Gaffel t/udv. rør 751200 Ø30,0 mm Gaffel t/indv. rør 751100 Ø34,5 mm Gaffel t/udv. rør 751500 Ø41,0 mm</p>
	<p>4000-201517 4000-203002 4000-2030119 4000-203005</p>	<p>Gafler med rundt hul Gaffel, 25 mm 8 mm not 10 mm gevindhul Gaffel, 30 mm 10 mm stifthul Gaffel, 30 mm 10 mm stifthul, t/Claas Gaffel, 30 mm 8 mm not 10 mm gevindhul</p>
	<p>4000-202300</p>	<p>Dobbeltgaffler Dobbeltgaffel</p>
	<p>4000-201600</p>	<p>Flangegaffler Flangegaffel 4 bolthuller Ø90,0 mm</p>
	<p>4000-650100 4000-650104 4000-650112</p>	<p>Snaplåse Snaplås, kpl. agraset® 100 Snaplås, t/21 noter 104 Snaplås, kpl. 101</p>

Vidvinkel, serie WW2270 - 70 grader

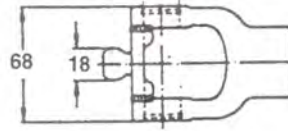
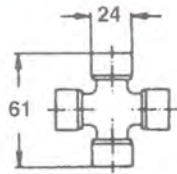

Kryds: 4000-200000

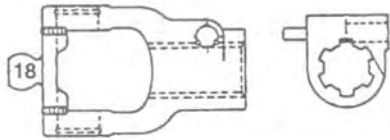

4000-201010

Notgaffler - 70 gr.
Notgaffler, 1 3/8" 6 noter

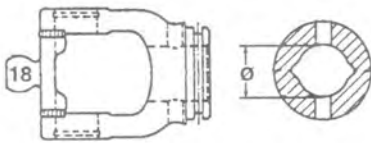

4000-201110
4000-201210

Gaffler til profilrør - 70 gr.
Gaffler t/indv. rør 751100 Ø34,5 mm
Gaffler t/udv. rør 751500 Ø41,0 mm

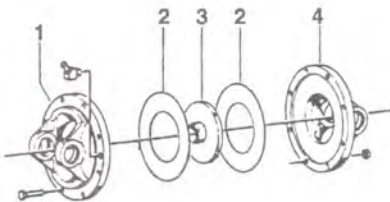

4000-204100
4000-606802
4000-900201
4000-204101

Flangegaffler - 70 gr.
1) Flangegaffler, smørbar
2) Glideskive, Ø 109 mm
3) Bøsning, Ø76 mm, Ø18 mm hul, 7 mm tyk
4) Flangegaffler, ikke smørbar

Vidvinkel, serie WW2280 - 80 grader

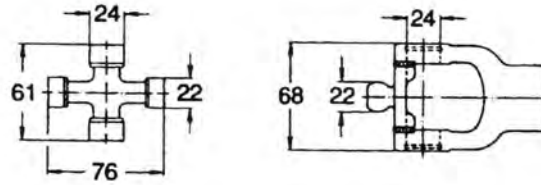

Kryds: 4000-200600

	<p>4000-2010810</p>	<p>Notgaffler - 80 gr. Notgaffel, 1 3/8" 6 noter</p>
	<p>4000-2011810 4000-2012810</p>	<p>Gaffler til profilrør - 80 gr. Gaffel t/indv. rør 751196 Ø34,5 mm Gaffel t/udv. rør 751600 Ø41,0 mm</p>
	<p>4000-209105</p>	<p>Mellemstykker - 80 gr. Mellemstykke</p>
	<p>4000-2015839</p>	<p>Gaffler med rundt hul - 80 gr. Gaffel, Ø20 mm 8 mm stifthul</p>

Gafler til kryds 210000, serie W2300

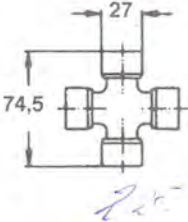
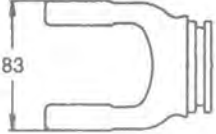
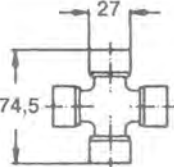
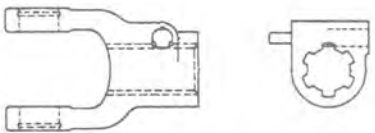
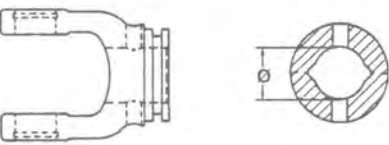
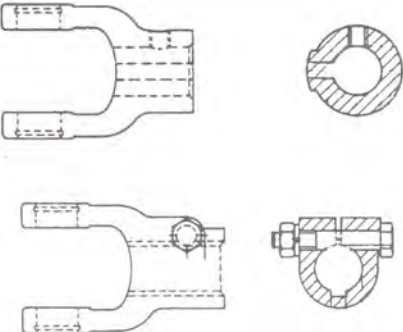
 <p>Kryds: 4000-210000</p>		
	<p>4000-210000 4000-210002</p>	<p>Kryds Kryds, standard Kryds m/langt smøreinterval</p>
	<p>4000-211700 4000-211000 4000-211900</p>	<p>Notgaffler Notgaffel, 1 1/8" 6 noter & snaplås Notgaffel, 1 3/8" 6 noter & snaplås Notgaffel, 1 3/8" 21 noter & snaplås</p>
	<p><i>2139</i> 4000-211100 4000-211200 4000-2122100 4000-2122101 4000-212300 4000-2124118</p>	<p>Gaffler til profilrør Gaffel t/indv. rør 751100 Ø34,5 mm Gaffel t/udv. rør 751500 Ø41,0 mm Gaffel t/indv. rør 752500 Ø39,5 mm Gaffel t/udv. rør 753500 Ø48,3 mm Gaffel t/indv. rør 753000 Ø50,0 mm Gaffel t/firk. profil 24 x 27 mm</p>
	<p>4000-213004 4000-213007 4000-212401 4000-212403 4000-212902 4000-211803 <i>815</i></p>	<p>Gaffler med rundt hul Gaffel, 30 mm 10 mm stifthul Gaffel, 30 mm 8 mm not 12 mm gevindhul Gaffel, 35 mm 13 mm stifthul Gaffel, 35 mm 10 mm not 12 mm gevindhul Gaffel, 30 mm 8 mm not & klembolt Gaffel, 35 mm 10 mm not & klembolt</p>
<p><i>14131</i></p>		<p>fortsættes.....</p>

Gafler til kryds 210000, serie W2300

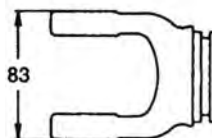
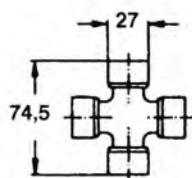

Kryds: 4000-210000

	<p>4000-212600</p>	<p>Dobbeltgafler Dobbeltgaffel</p>
	<p>4000-211600</p>	<p>Flangegafler Flangegaffel 6 bolthuller Ø100,0 mm</p>
	<p>4000-650100 4000-650104 4000-650112</p>	<p>Snaplåse agraset® Snaplås, kpl. 100 Snaplås, t/21 noter 104 Snaplås, kpl. 101</p>

Vidvinkel, serie WW2370 - 70 grader

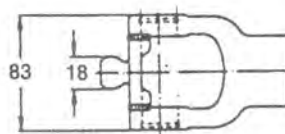
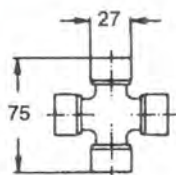

Kryds: 4000-210000

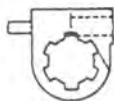
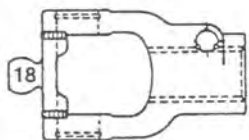

4000-211010
4000-211910

Notgaffler - 70 gr.

Notgaffel, 1 3/8" 6 noter
Notgaffel, 1 3/8" 21 noter

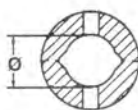
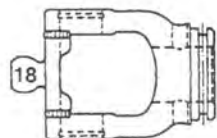

4000-211110
4000-211210
4000-214210
4000-214310

Gaffler til profilrør - 70 gr.

Gaffel t/indv. rør 751196 Ø34,5 mm
Gaffel t/udv. rør 751600 Ø41,0 mm
Gaffel t/indv. rør 752595 Ø39,5 mm
Gaffel t/udv. rør 753600 Ø48,3 mm

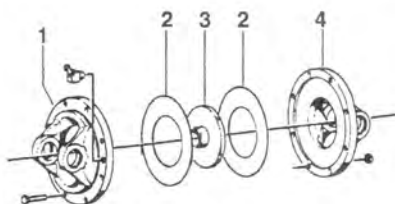

4000-214100
4000-606800
4000-900001
4000-214101

Flangegaffler - 70 gr.

- 1) Flangegaffel, smørbar
- 2) Glideskive, Ø 118 mm
- 3) Bøsning, Ø80 mm, Ø18 mm hul, 7 mm tyk
- 4) Flangegaffel, ikke smørbar

Vidvinkel, serie WW2380 - 80 grader

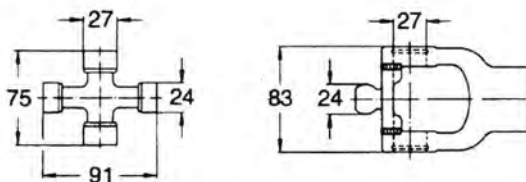

Kryds: 4000-210600

	<p>4000-2110810 4000-2119810</p>	<p>Notgafler - 80 gr. Notgaffel, 1 3/8" 6 noter Notgaffel, 1 3/8" 21 noter</p>
	<p>4000-2111810 4000-2112810 4000-2142810</p>	<p>Gafler til profilrør - 80 gr. Gaffel t/indv. rør 751196 Ø34,5 mm Gaffel t/udv. rør 751600 Ø41,0 mm Gaffel t/indv. rør 752595 Ø39,5 mm</p>
	<p>4000-219105</p>	<p>Mellemstykker - 80 gr. Mellemstykke</p>

Gafler til kryds 220000, serie W220

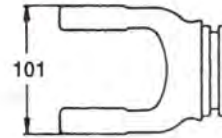
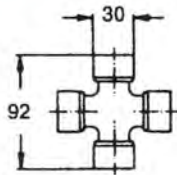

Kryds: 4000-220000

	<p>4000-221000 4000-221900</p> <p>4000-221010</p>	<p>Notgaffler Notgaffel, 1 3/8" 6 noter & snaplås Notgaffel, 1 3/8" 21 noter & snaplås</p> <p>Notgaffel, 1 3/8" m/snaplås - t/vidvinkel</p>
	<p>4000-221100 4000-221200</p> <p>4000-221110 4000-221210</p>	<p>Gafler til profilrør Gaffel t/indv. rør 752500 Ø39,5 mm Gaffel t/udv. rør 753500 Ø48,0 mm</p> <p>Gaffel t/indv. rør 752595 t/vidvinkel Gaffel t/udv. rør 753600 t/vidvinkel</p>
	<p>4000-224100 4000-606801 4000-900101 4000-224101</p>	<p>Flangegaffler til vidvinkel 1) Flangegaffel, smørbar, 8 bolthuller 2) Glideskive, Ø 133 mm 3) Bøsning, Ø90 mm, Ø22 mm hul, 8 mm tyk 4) Flangegaffel, ikke smørbar, 8 bolthuller</p>
	<p>4000-650100</p> <p>4000-650104</p>	<p>Snaplåse Snaplås, kpl. agraset® 100</p> <p>Snaplås, t/21 noter 104</p>

April 1999

Gafler til kryds 240100, serie 240

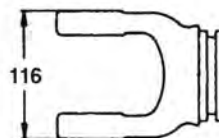
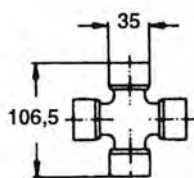

Kryds: 4000-240100

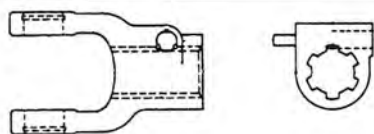

4000-241000
4000-241800
4000-2415107

Notgafler

Notgaffel, 1 3/8" 6 noter & snaplås
Notgaffel, 1 3/8" 21 noter & snaplås
Notgaffel, 1 1/2" 10 noter u/snaplås

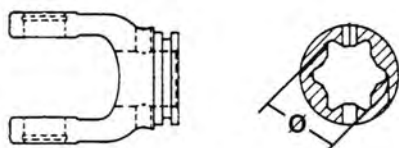

4000-241100
4000-241200

Gafler til stjernehjør

Gaffel t/indv. stjerneaksel 754400 Ø51,0 mm
Gaffel t/udv. stjernehjør 754500 Ø61,0 mm

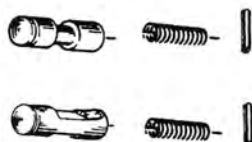

4000-650100

Snaplås

Snaplås, kpl.

agraset®

100

4000-650104

Snaplås, t/21 noter

104

Gafler til kryds 260000, serie W2600

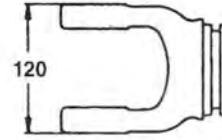
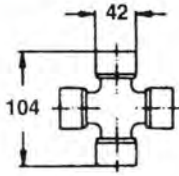

Kryds: 4000-260000

	<p>4000-261000 4000-261002</p>	<p>Notgaffler Notgaffel, 1 3/8" 6 noter & snaplås Notgaffel, 1 3/8" 21 noter & snaplås</p>
	<p>4000-2613100 4000-2614100 4000-261300 4000-261400</p>	<p>Gaffler til stjerneør Gaffel t/indv. stjerneaksel 754400 Ø51,0 mm Gaffel t/udv. stjerneør 754500 Ø61,0 mm Gaffel t/indv. stjerneaksel S5 Ø61,0 mm Gaffel t/udv. stjerneør S6 Ø71,5 mm</p>
	<p>4000-650112 4000-339302</p>	<p>Snaplåse Snaplås, kpl. agraset® 101 Snaplås, kpl., 1 3/4" 102</p>

Gafler til kryds 350000, serie W2400

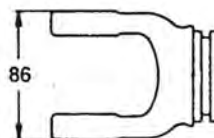
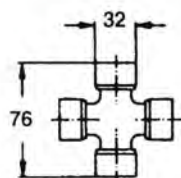

Kryds: 4000-350000

	<p>4000-350000 4000-350002</p>	<p>Kryds Kryds, standard Kryds m/langt smøreinterval</p>
	<p>4000-351000 4000-351002 4000-351800 4000-351802 4000-351004 4000-351006 4000-351804</p>	<p>Notgaffler Notgaffel, 1 3/8" 6 noter & snaplås Notgaffel, 1 3/8" 21 noter & snaplås Notgaffel, 1 3/4" 6 noter & snaplås Notgaffel, 1 3/4" 20 noter & snaplås Notgaffel, 1 3/8" 6 noter & klembolt Notgaffel, 1 3/8" 21 noter & klembolt Notgaffel, 1 3/4" 6 noter & klembolt</p>
	<p>4000-351300 4000-351400</p>	<p>Gaffler til profilrør Gaffel t/indv. rør 752500 Ø39,5 mm Gaffel t/udv. rør 753500 Ø48,0 mm</p>
	<p>4000-3513100 4000-3514100</p>	<p>Gaffler til stjerneør Gaffel t/indv. stjerneaksel 754400 Ø51,0 mm Gaffel t/udv. stjerneør 754500" Ø61,0 mm</p>
	<p>4000-352200 4000-3522108 4000-352412 4000-352413 4000-352410 4000-351808</p>	<p>Gaffler med rundt hul Gaffel, 35 mm 13 mm stifthul Gaffel, 35 mm 12 mm stifthul t/Taarup Gaffel, 35 mm 10 mm not Gaffel, 40 mm 13 mm stifthul Gaffel, 40 mm 12 mm not Gaffel, 40 mm 12 mm not & klembolt</p>

fortsættes.....

Gafler til kryds 350000, serie W2400

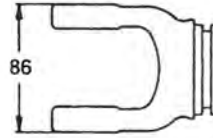
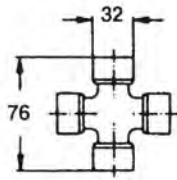

Kryds: 4000-350000

	<p>4000-352800</p>	<p>Dobbeltgafler Dobbeltgaffel</p>
	<p>4000-351600 4000-351902 4000-352700 4000-3537102 4000-3539101</p>	<p>Flangegafler Flangegaffel 6 bolthuller Ø100 mm Flangegaffel 6 bolthuller Ø160 mm Flangegaffel 8 bolthuller Ø120 mm Flangegaffel a) 79,20 mm b) t/1/2" stift N.H. Flangegaffel a) 99,92 mm b) t/9/16" stift N.H.</p>
	<p>4000-650112 4000-339302</p>	<p>Snaplåse Snaplås, kpl. agraset® 101 Snaplås, kpl., 1 3/4" 102</p>

Vidvinkel, serie W2480 - 80 grader

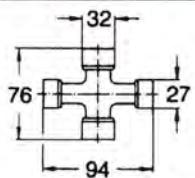
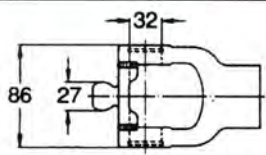
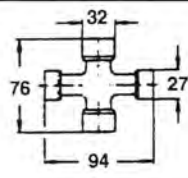
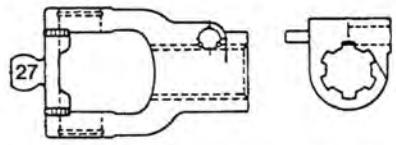
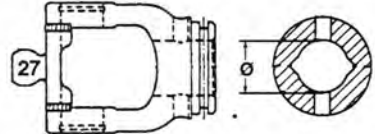
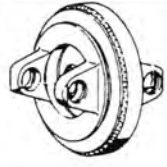
<p>Kryds: 4000-350600</p>  		
	<p>4000-350600</p>	<p>Kryds - 80 grader Kryds, spec., 27 - & 32 mm nødder</p>
	<p>4000-351010 4000-351012 4000-351810 4000-351812</p>	<p>Notgaffler - 80 grader Notgaffel, 1 3/8" 6 noter Notgaffel, 1 3/8" 21 noter Notgaffel, 1 3/4" 6 noter Notgaffel, 1 3/4" 20 noter</p>
	<p>4000-351310 4000-351410</p>	<p>Gaffler til profilrør - 80 grader Gaffel t/indv. rør 752595 Ø39,5 mm Gaffel t/udv. rør 753600 Ø48,0 mm</p>
	<p>4000-354105</p>	<p>Mellemstykker - 80 grader Mellemstykke</p>

Vidvinkel, serie W2450 - 50 grader

<p>Kryds: 4000-350050</p>  		
	<p>4000-350050</p>	<p>Kryds - 50 grader Kryds, spec., 32 x 76 mm, med smørenippel i nød og smøreslange</p>
	<p>4000-3514510</p>	<p>Gaffler til profilrør - 50 grader Gaffel t/udv. rør 753600 Ø48,0 mm</p>
	<p>4000-358900</p>	<p>Mellemstykker - 50 grader Mellemstykke</p>

Gafler til kryds 360000, serie W2500

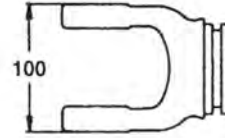
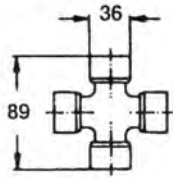

Kryds: 4000-360000

	<p>4000-360000 4000-360002</p>	<p>Kryds Kryds, standard Kryds m/langt smøreinterval</p>
	<p>4000-361000 4000-361002 4000-3622112 4000-361800 4000-361008 4000-361804 4000-361806</p>	<p>Notgaffler Notgaffel, 1 3/8" 6 noter & snaplås Notgaffel, 1 3/8" 21 noter & snaplås Notgaffel, 1 1/2" 10 noter u/snaplås Notgaffel, 1 3/4" 6 noter & snaplås Notgaffel, 1 3/8" 6 noter & klembolt Notgaffel, 1 3/4" 6 noter & klembolt Notgaffel, 1 3/4" 20 noter & klembolt</p>
	<p>4000-361300 4000-361400</p>	<p>Gaffler til profilrør Gaffel t/indv. rør 752500 Ø39,5 mm Gaffel t/udv. rør 753500 Ø48,0 mm</p>
	<p>4000-3613100 4000-3614100</p>	<p>Gaffler til stjerneør Gaffel t/indv. stjerneaksel 754400 Ø51,0 mm Gaffel t/udv. stjerneør 754500 Ø61,0 mm</p>
	<p>4000-3624108 4000-362402 4000-361808</p>	<p>Gaffler med rundt hul Gaffel, 40 mm 12 mm not Gaffel, 45 mm 14 mm not Gaffel, 40 mm 12 mm not & klembolt</p>
		<p style="text-align: right;">fortsættes.....</p>

Gafler til kryds 360000, serie W2500

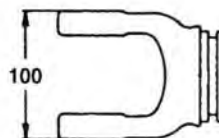
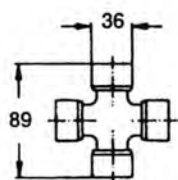

Kryds: 4000-360000

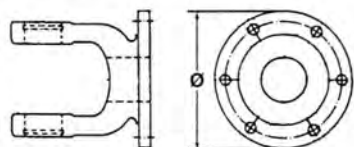

4000-361902
4000-3673100
4000-362700

Flangegaffler

Flangegaffel 6 bolthuller Ø160 mm
Flangegaffel 6 bolthuller Ø190 mm t/Howard
Flangegaffel 8 bolthuller Ø120 mm

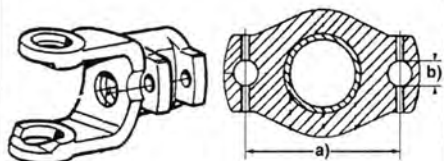

4000-3637100

Flangegaffel a) 79,20 mm b) t/1/2" stift N.H.

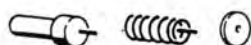

4000-650112

Snaplåse

Snaplås, kpl.

agraset®

101

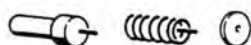

4000-339302

Snaplås, kpl., 1 3/4"

102

Vidvinkel, serie WW2580 - 80 grader

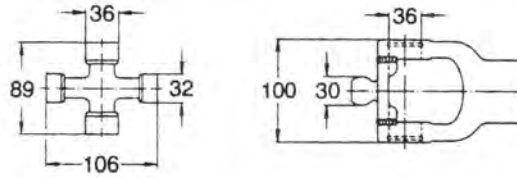

Kryds: 4000-360600

	<p>4000-360600</p>	<p>Kryds - 80 grader Kryds, spec., 32 - & 36 mm nødder</p>																					
	<p>4000-361010 4000-361012 4000-361014 4000-3610832 4000-361810 4000-361812 4000-3618832</p>	<p>Notgaffler - 80 grader</p> <table border="0"> <tr> <td>Notgaffel, 1 3/8"</td> <td>6 noter</td> <td></td> </tr> <tr> <td>Notgaffel, 1 3/8"</td> <td>21 noter</td> <td></td> </tr> <tr> <td>Notgaffel, 1 3/8"</td> <td>21 noter</td> <td>m/klembolt</td> </tr> <tr> <td>Notgaffel, 1 3/8"</td> <td>21 noter</td> <td>m/konusbolt</td> </tr> <tr> <td>Notgaffel, 1 3/4"</td> <td>6 noter</td> <td></td> </tr> <tr> <td>Notgaffel, 1 3/4"</td> <td>20 noter</td> <td></td> </tr> <tr> <td>Notgaffel, 1 3/4"</td> <td>20 noter</td> <td>m/konusbolt</td> </tr> </table>	Notgaffel, 1 3/8"	6 noter		Notgaffel, 1 3/8"	21 noter		Notgaffel, 1 3/8"	21 noter	m/klembolt	Notgaffel, 1 3/8"	21 noter	m/konusbolt	Notgaffel, 1 3/4"	6 noter		Notgaffel, 1 3/4"	20 noter		Notgaffel, 1 3/4"	20 noter	m/konusbolt
Notgaffel, 1 3/8"	6 noter																						
Notgaffel, 1 3/8"	21 noter																						
Notgaffel, 1 3/8"	21 noter	m/klembolt																					
Notgaffel, 1 3/8"	21 noter	m/konusbolt																					
Notgaffel, 1 3/4"	6 noter																						
Notgaffel, 1 3/4"	20 noter																						
Notgaffel, 1 3/4"	20 noter	m/konusbolt																					
	<p>4000-3613104 4000-3614116</p>	<p>Gaffler til stjerneør - 80 grader</p> <table border="0"> <tr> <td>Gaffel t/indv. stjerneaksel</td> <td>754498</td> <td>51,0 mm</td> </tr> <tr> <td>Gaffel t/udv. stjerneør</td> <td>754500</td> <td>61,0 mm</td> </tr> </table>	Gaffel t/indv. stjerneaksel	754498	51,0 mm	Gaffel t/udv. stjerneør	754500	61,0 mm															
Gaffel t/indv. stjerneaksel	754498	51,0 mm																					
Gaffel t/udv. stjerneør	754500	61,0 mm																					
	<p>4000-364105</p>	<p>Mellemstykker - 80 grader Mellemstykke</p>																					
	<p>4000-361910</p>	<p>Flangegaffler - 80 grader Flangegaffel 6 bolthuller Ø160,0 mm</p>																					

Boltkobling

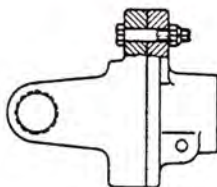

Kpl. kobling	Sprængningsmoment	Sprængbolt	Kryds
4000-22612-1220	1220 Nm	(8 x 40 mm)	200000
4000-23612-1430	1430 Nm	4000-601101 (7 x 50 mm)	210000
4000-24612-2500	2500 Nm	(10 x 60 mm)	350000
4000-25612-2900	2900 Nm	(10 x 60 mm)	360000

Speciel aksel til Taarup 336 - 337 - 338 - 339

	Pos.	Grp. - varenr.	Benævnelse
	1	4000-2038134	Notgaffel, 1 3/4" - 6 (99235511)
2	4000-200000	Kryds (99235503)	
3	4000-201200	Gaffel t/ udv. profilrør (99235508)	
4	4000-751500	Profilrør	
5	4000-2064100	Flangegaffel (99235513)	
6	5600-68678000	Aksel, kpl.	

Stiffriløb F3

(Erst. af F5/1)

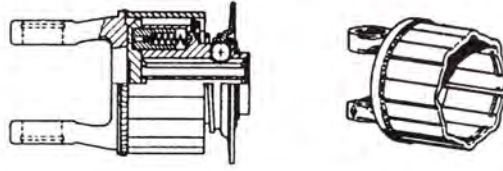

Kpl. stiffriløb	Koblingshus	Kryds
4000-5610402 4000-5610802	4000-551012	100100
	4000-551136	110300
	4000-551239	120000
	4000-203138	200000
4000-5611002	4000-213141	210000
		220000
	4000-353119	350000

Reservedele:

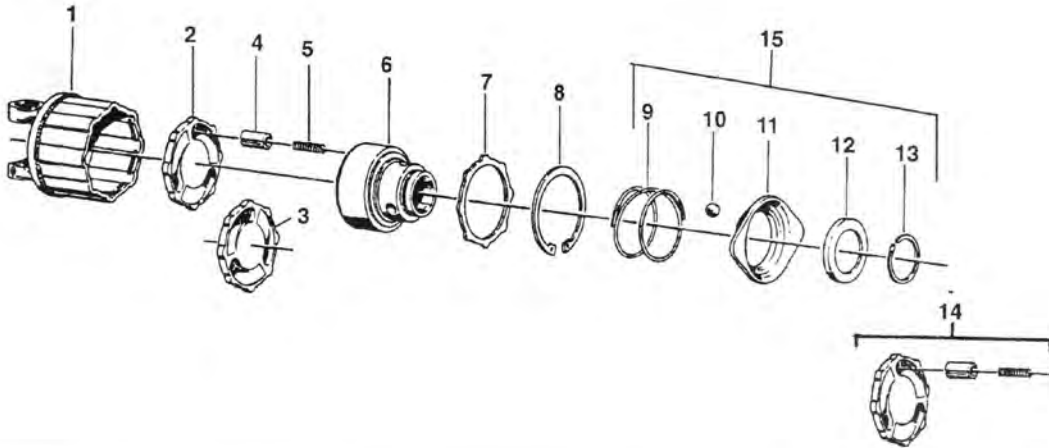

Pos.	Grp. - varenr.	Benævnelse	Bemærkninger	agraset®
1	Se ovenfor	Koblingshus		
2	4000-561200	Medløbsskive	højre	
3	4000-561300	Medløbsskive	venstre	
4	4000-567801	Cylinderrulle	(6 stk. pr. nav)	
5	4000-660100	Trykfjeder	(6 stk. pr. nav)	
6	4000-561105	Nav, 1 3/8" m/6 noter		
6	4000-5611100	Nav, Ø 35 mm m/glat hul	t/Bredal (ikke ill.)	
7	4000-551510	Trykskive		
8	1115-100080	Sikringsring		
9	4000-660146	Trykfjeder		
9	4000-660102	Trykfjeder	gl. model (ikke ill.)	
10	4000-640200	Stålrulle, 1/2" t/1 1/8" nav	(ikke ill.)	
10	7500-RB 1/2	Stålkugle, 1/2" t/1 3/8" nav		
11	4000-650305	Spærremuffe, 1 3/8"		
11	4000-650300	Spærremuffe, 1 3/8"	gl. model, firkantet (ikke ill.)	
12	4000-162014	Anlægsskive		
12	4000-551900	Anlægsskive	gl. model (ikke ill.)	
13	4000-620700	Sikringsring		
14	4000-341954	Medbringerskivesæt	F3, højre	
15	4000-341953	ZV låsesæt		

Friløbskobling F5/1

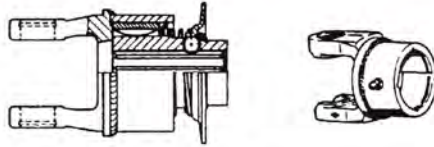

Kpl. friløb	Højre/ venstre	Koblingshus	Kryds	Bemærkninger
4000-5614740	H	4000-551038	100100	
4000-5614040	H	4000-203144	200000	
4000-5614140	H	4000-213156	210000	
4000-5614340	V	4000-213160	210000	
4000-5611002			220000	
4000-5614440	H	4000-353153	350000	Ø40 mm, glat hul t/JF
4000-5613840	H		350000	
4000-5613740	V	4000-353154	350000	
4000-5618940	V	4000-353154	350000	1 3/8" - 6 noter m/klembolt
4000-5610440	H	4000-363126	360000	
	V	4000-363127	360000	
4000-5611940	H		360000	1 3/4" - 6 noter m/klembolt
1) 4000-5612340	H		360600	F5/1 friløbskobling t/vidvinkel

1) Bemærk: Vidvinkelkobling!

Reserve dele til F5 & F5/1:

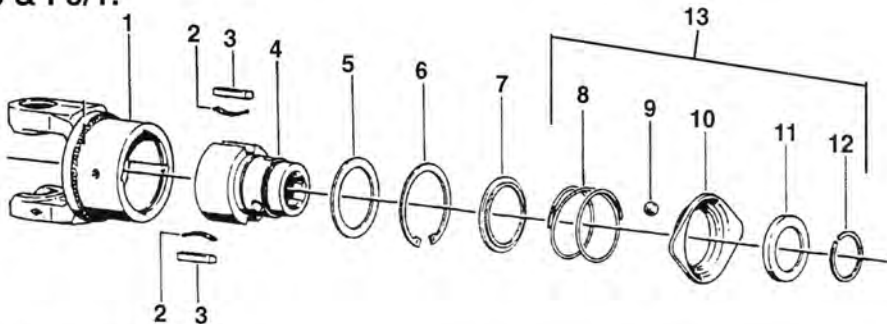

Pos.	Grp. - varenr.	Benævnelse	Bemærkninger	agraset®
1	Se ovenfor	Koblingshus		
2	4000-661900	Bladfjeder	t/F5 & F5/2	
2	4000-661901	Bladfjeder	t/F5/1	
3	4000-165025	Låsekile, 49,5 mm	t/F5	
3	4000-165035	Låsekile, 37,8 mm	t/F5/1	
3	4000-165043	Låsekile, 61,5 mm	t/F5/2	
4	4000-561912	Nav, 1 3/8" m/6 noter	t/F5/1	
4	4000-561913	Nav, 1 3/8" m/21 noter	t/F5/1	
5	4000-162067	Støtteskive, 56 x 72 mm		
6	1115-100072	Låsering	indvendig	
7	4000-162016	Støttering		
8	4000-660146	Trykfjeder		
9	7500-RB 1/2"	Stålkugle, 1/2" t/1 1/8" nav		
9	4000-640200	Stålrulle, 1/2" t/1 1/8" nav	(ikke ill.)	
10	4000-650305	Spærremuffe, 1 3/8"		
11	4000-162052	Vinkelring		
12	4000-621002	Låsering		
13	4000-341953	ZV låsesæt		108

Bemærk! F5 er med kugleleje
F5/1 er uden kugleleje

Sikkerhedskoblinger K31, K32, K33, K34



Moment-indstilling	K-nr.	Sikkerhedskobling, kpl.	Nav	Koblingshus	Kryds
26 kg	1) K31 - 1 1/8"	4000-5559803	1 rk.		100100
30 kg	K31 - 1 3/8"	4000-5536903	1 rk.		100100
50 kg	K32 - 1 3/8"	4000-5528803	2 rk.	4000-551415	100100
50 kg	1) K32 - 1 1/8"	4000-5557803	2 rk.	4000-551416	100100
	2) K32 - 1 3/8"		2 rk.	4000-551415	110300
	1) K32 - 1 1/8"	4000-5519703	2 rk.	4000-551416	200000
	3) K32 - 1 3/8"		2 rk.	4000-551415	210000
70 kg	K33 - 1 3/8"	4000-5519803	3 rk.	4000-551418	200000
80 kg	K33 - 1 3/8"	4000-5544303	3 rk.	4000-551418	110300
	1) K33 - 1 1/8"		3 rk.	4000-551419	210000
80 kg	K33 - 1 3/8"	4000-5520203	3 rk.	4000-551418	210000
	K33 - 1 3/8"		3 rk.	4000-551418	220000
120 kg	K34 - 1 3/8"	4000-5563903	4 rk.	4000-551421	120000
90 kg	K34 - 1 3/8"	4000-5520403	4 rk.	4000-551421	210000
120 kg	K34 - 1 3/8"		4 rk.	4000-551421	220000
120 kg	K34 - 1 3/8"	4000-5553503	4 rk.	4000-551421	350000

1) 1 1/8" nav

2) K32, kpl. kobling, 2 rk. t/kryds 110300 erstattes af K33 kpl. kobling, 3 rk. t/kryds 110300

3) K32, kpl. kobling, 2 rk. t/kryds 210000 erstattes af K33 kpl. kobling, 3 rkr. t/kryds 210000

1 kg x 0,77 = 1 Hk

Kpl. nokke m/fjeder = 3,75 kg

nokke m/udv. fjeder = 2,50 kg

	Max. belastning	L = længde på koblingshus
1-rækket nav	K31 = 30 kg	36
2-rækket nav	K32 = 60 kg	55
3-rækket nav	K33 = 90 kg	74
4-rækket nav	K34 = 120 kg	93

Sikkerhedskobling - vidvinkel 70 grader



Moment-indstilling	K-nr.	Sikkerhedskobling, kpl.	Nav	Koblingshus	Kryds
60 kg	K33	4000-5532903	3 rk.	4000-551418	200000

April 1999

Reserve dele til sikkerhedskoblinger

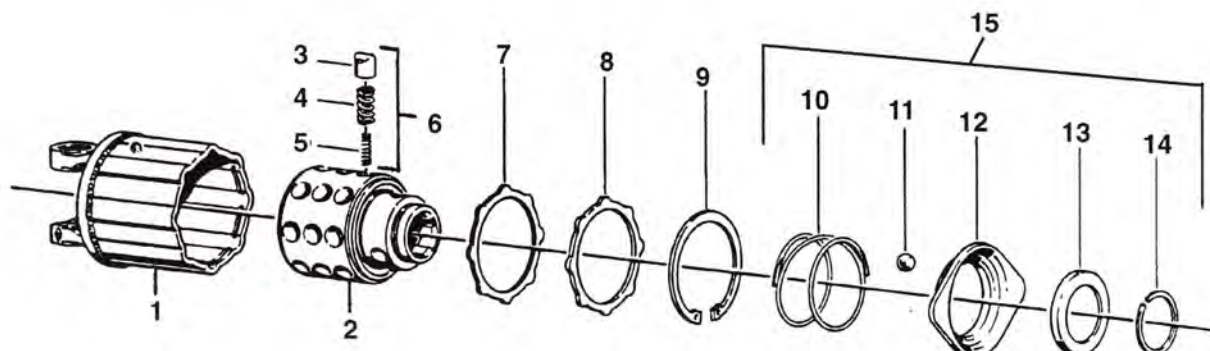

Pos.	Grp. - varenr.	Benævnelse	Bemærkninger	agraset®
1	Se forrige side	Koblingshus		
2	Se forrige side	Nav		
3	4000-550103	Nokke, Ø16 mm	(8 stk. pr. række)	
4	4000-660104	Fjeder, udv.	(8 stk. pr. række)	
5	4000-660105	Fjeder, indv.	(8 stk. pr. række)	
6	4000-561105	Nav, 1 3/8" m/6 noter		
6	4000-341951	Reparationssæt	(8 stk. nokker, 8 stk. udv. fjeder, 8 stk. indv. fjeder)	
7	4000-551712	Fiberskive		
7	4000-551711	Anlægsskive	gl. model (ikke ill.)	
8	4000-551510	Trykskive		
8	4000-551500	Trykskive	gl. model (ikke ill.)	
9	1115-100080	Sikringsring		
10	4000-660146	Trykfjeder		
10	4000-660102	Trykfjeder	gl. model (ikke ill.)	
11	7500-RB 1/2"	Stålkugle, 1/2" t/1 3/8" nav		
11	4000-640200	Stålrulle, t/1 1/8" nav		
12	4000-650305	Spærremuffe, 1 3/8"		
12	4000-650300	Spærremuffe, 1 3/8"	gl. model, firkantet (ikke ill.)	
13	4000-162014	Anlægsskive		
13	4000-551900	Anlægsskive	gl. model (ikke ill.)	
14	4000-620700	Sikringsring		
15	4000-341953	ZV låsesæt		108

Ved udskiftning fra **gl. model nav** (m/firkantet spærremuffe) til **ny model nav** (m/oval spærremuffe anvendes: pos. nr. 10, 11, & 12, ny model.

Ved udskiftning til **ny model koblingshus** (m/runde kanter) anvendes:

1 stk. 4000-551712, fiberskive + 1 stk. 4000-551510, trykskive

Friktionskobling K91

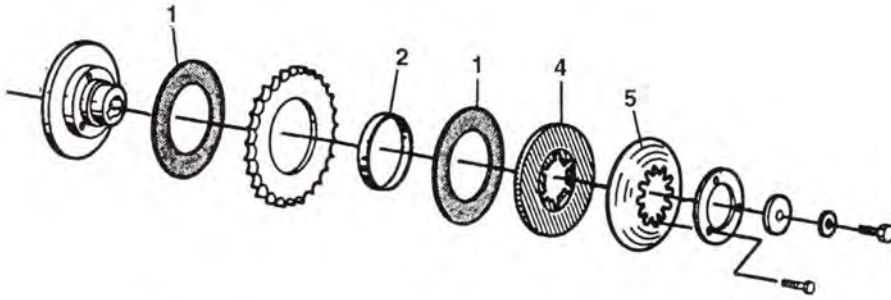

Pos.	Grp. - varenr.	Benævnelse
1	4000-567308	Koblingsbelægning
2	4000-1650171	Løbering
3	4000-566200	Trykskive
4	4000-661300	Tallerkenfjeder, 3,2 mm
4	4000-661400	Tallerkenfjeder, 2,8 mm
5	4000-566300	Spændeplade

Friktionskobling K92 & K92/4

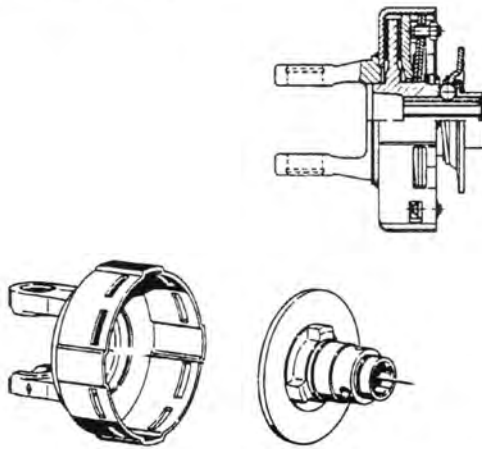

Friktionskobling kpl.	Koblingshus	Koblingsnav	Kryds	Momentindstilling	Tilslutning
1) 4000-5621616	4000-203132	4000-566411	200000	K92 - 750 Nm	1 1/8" - 6 noter
4000-5611316	4000-203132	4000-566409	200000	K92 - 750 Nm	1 3/8" - 6 noter
4000-5611516		4000-566409	210000	K92 - 750 Nm	1 3/8" - 6 noter
4000-5621816	4000-216402	2) 4000-566412	210000	K92/4 - 1050 Nm	1 3/8" - 6 noter
4000-5622116	4000-356201	4000-566412	350000	K92/4 - 1350 Nm	1 3/8" - 6 noter

1) Bemærk: 1 1/8" nav

2) I tilfælde, hvor nav 566412 er med Ø50 mm nav:

Anvend 1 stk. 4000-162052, vinkelring & 1 stk. 4000-621002, springring

Momentindstilling - se side 4.034!

Reserve dele til friktionskobling K92 & K92/4

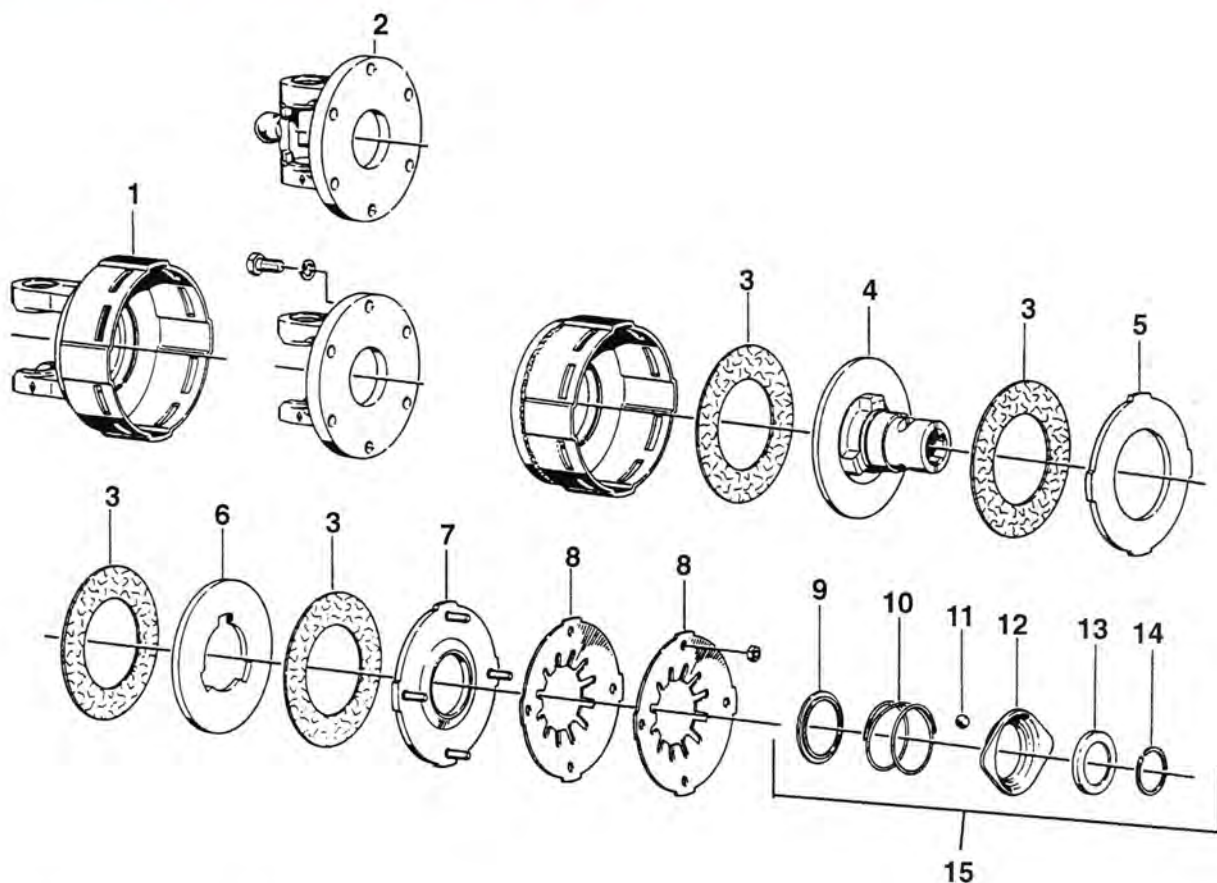

Pos.	Grp. - varenr.	Benævnelse	Bemærkninger	agraset®
1	Se side 32	Koblingshus	NB!	
2	4000-361910	Flangegaffel t/vidvinkel	t/K92/4 & 360000 kryds	
3	4000-567308	Koblingsbelægning	asbestfri (2 eller 4 stk.)	
4	Se side 4.032	Nav	NB!	
5	4000-566602	Skive	t/K92/4	
6	4000-566701	Medbringerskive	t/K92/4	
7	4000-566619	Trykskive	t/K92 & K92/4	
8	4000-661600	Tallerkenfjeder, 2,6 mm	grøn	
8	4000-660900	Tallerkenfjeder, 3,0 mm	hvid	
8	4000-661000	Tallerkenfjeder, 3,5 mm	rød	
9	4000-162016	Støttering	t/K92	
10	4000-660146	Fjeder		
11	7500-RB 1/2	Stålkugle, 1/2" t/1 3/8" nav		
12	4000-650305	Spærremuffe, 1 3/8"		
13	4000-162014	Vinkelring, Ø42 mm	t/gl. type nav	
13	4000-162052	Vinkelring, Ø50 mm		
14	4000-620700	Låserring, Ø42 mm	udv., t/gl. type nav	
14	4000-621002	Låserring, Ø50 mm	udv.	
15	4000-341953	ZV låsesæt		108

Bemærk! K92 er med 2 stk. belægning
K92/4 er med 4 stk. belægning

Momentindstilling - se side 4.034!

Momentindstilling af K92 & K92/4



Type	Moment	Antal & tykkelse	Grp. - varenummer	Farve-markering
K92	200 Nm	1 x 2,6 mm	4000-661600	grøn
	300 Nm	1 x 3,0 mm	4000-660900	hvid
	450 Nm	1 x 3,5 mm	4000-661000	rød
	550 Nm	1 x 2,6 mm	4000-661600	grøn
		1 x 3,0 mm	4000-660900	hvid
	650 Nm	2 x 3,0 mm	4000-660900	hvid
	770 Nm	1 x 3,0 mm	4000-660900	hvid
		1 x 3,5 mm	4000-661000	rød
	900 Nm	2 x 3,5 mm	4000-661000	rød
K92/4	550 Nm	1 x 3,0 mm	4000-660900	hvid
	800 Nm	1 x 3,5 mm	4000-661000	rød
	1050 Nm	2 x 3,0 mm	4000-660900	hvid
	1200 Nm	1 x 2,6 mm	4000-661600	grøn
		1 x 3,5 mm	4000-661000	rød
	1350 Nm	1 x 3,0 mm	4000-660900	hvid
		1 x 3,5 mm	4000-661000	rød
1500 Nm	2 x 3,5 mm	4000-661000	rød	

Friktionsbelægninger



Grp.-varenummer	Mål	Anvendelse
4000-567313	56 x 90 x 4,5	K94/1
4000-567308	91 x 153 x 3,0	K90, K91, K92
4000-567312	100 x 160 x 3,0	K96, K96/4, FK96, FK96/4
4000-567315	102 x 170 x 3,2	K93, FK93

Friktionskobling K96, K96/4 & EK96/4

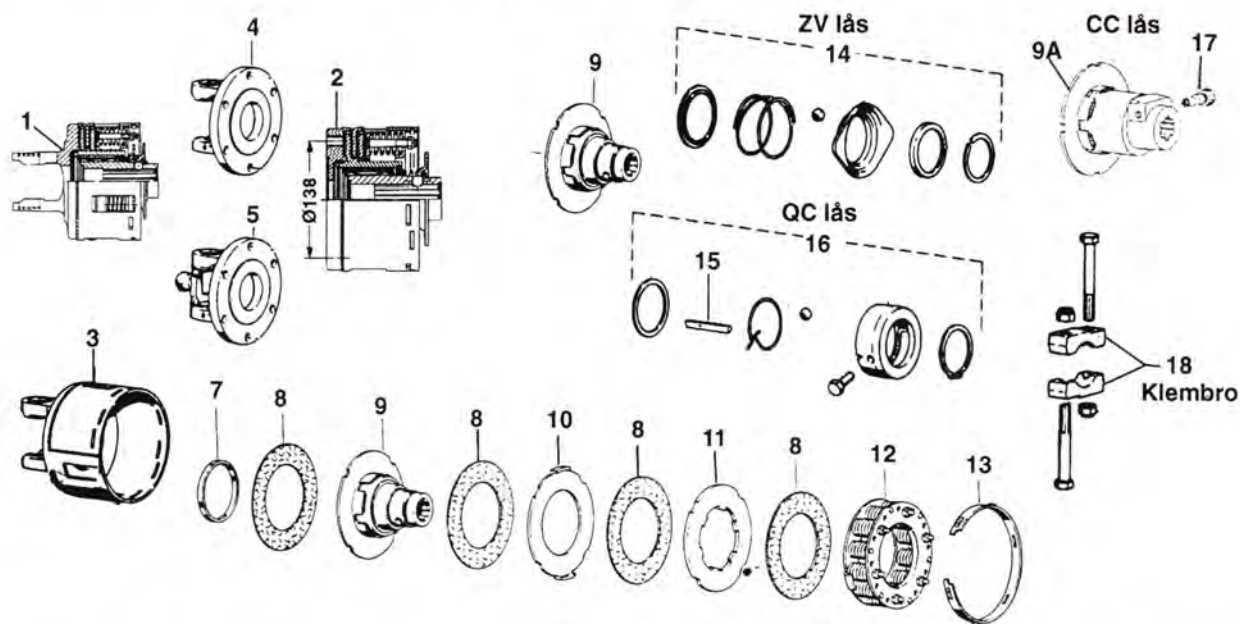

Pos.	Grp. - varenr.	Benævnelse	Bemærkninger	agraset®
1	4000-5610051	Kobling, kpl	K96/4, 1 3/8" - 6, kryds 350000	
2	4000-5614251	Kobling u/flange	K96/4, 1 3/8" - 6	
3	4000-359001	Koblingshus	K96	
3	4000-359002	Koblingshus	K96/4	
4	4000-351902	Flangegaffel	t/350000 kryds	
4	4000-361902	Flangegaffel	t/360000 kryds	
5	4000-361910	Flangegaffel, vidvinkel	t/360000 kryds	
7	4000-165206	Ring		
8	4000-567312	Koblingsbelægning	asbestfri (2 eller 4 stk.)	
9	4000-563002	Nav	K96, 1 3/8" - 6 t/QC lås	
9	4000-563102	Nav	K96/4, 1 3/8" - 6 t/QC lås	
9	4000-563104	Nav	K96/4, 1 3/4" - 6 t/QC lås	
9A	4000-563118	Nav	K96/4, 1 3/4" - 6 t/CC lås	
10	4000-563403	Medbringerskive	K96/4	
11	4000-563402	Medbringerskive	K96/4	
12	4000-563501	Fjedersæt	75/150	
12	4000-563501-1	Fjedersæt	60/120	
12	4000-563501-4	Fjedersæt	105/210	
13	4000-563600	Justerring		
14	4000-341953	ZV låsesæt	t/1 3/8" nav	108
15	4000-165042	Kile	t/QC lås	
16	4000-376108	Låsesæt	QC t/1 3/8" nav	125
16	4000-376109	Låsesæt	QC t/1 3/4" nav	126
17	4000-651206	Klemkonus	K96 & K96/4 t/1 3/8" nav	
17	4000-651208	Klemkonus	K96/4, t/1 3/4" nav	
18	4000-162051	Klembrohalvpart	1 3/8"	
18	4000-162099	Klembrohalvpart	1 3/4"	

Bemærk! K96 er med 2 stk. belægning
 K96/4 er med 4 stk. belægning
 K96/4 er med 4 stk. belægning

Momentindstilling - se side 4.037!

Kombineret friktions- & friløbskobling FK96 & FK96/4

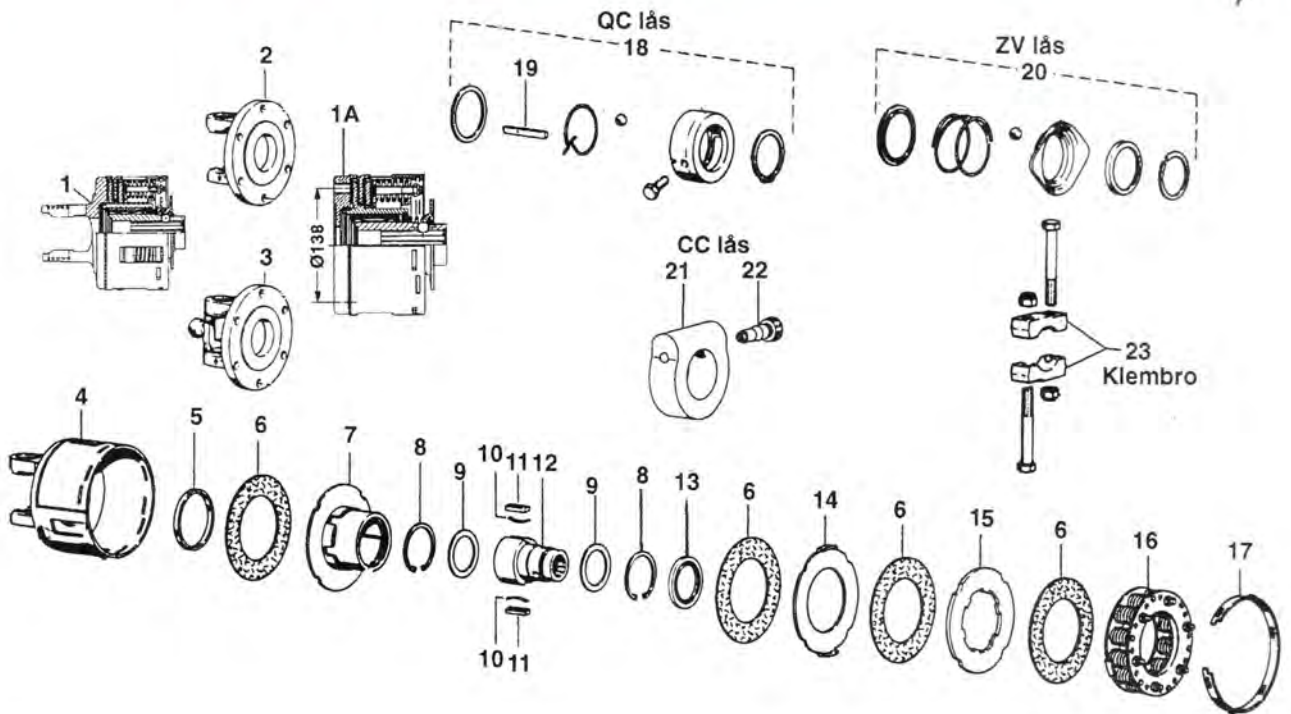

Pos.	Grp. - varenr.	Benævnelse	Bemærkninger	agraset®
1	4000-5813951	Fri- friktionskobling, kpl., 1500 Nm	1 3/8" - 6, m/klemkonus, kryds 350000	
1A	4000-25006-1500	Fri- friktionskobling u/flange	EFBK 96/4, 1 3/4" - 6, m/klembro	
2	4000-351902	Flangegaffel	t/350000 kryds	
2	4000-361902	Flangegaffel	t/360000 kryds	
3	4000-361910	Flangegaffel, vidvinkel	t/360000 kryds	
4	4000-359001	Koblingshus	FK96, t/350000 kryds	
4	4000-359002	Koblingshus	FK96/4, t/350000 kryds	
5	4000-165206	Ring		
6	4000-567312	Koblingsbelægning	asbestfri	
7	4000-586040	Medbringer	højre	
7	4000-586042	Medbringer	venstre	
8	1115-100072	Låsering	indv.	
9	4000-162067	Skive		
10	4000-661900	Bladfjeder, 48 mm		
11	4000-165025	Låsekile, 49,5 mm		
12	4000-561939	Nav	FK96, 1 3/8" - 6 t/QC lås	
12	4000-561963	Nav	FK96/4, 1 3/8" - 6 t/CC lås	
13	4000-681802	Pakring		
14	4000-563403	Medbringerskive	FK96/4	
15	4000-563402	Medbringerskive	K96/4 & FK96/4	
16	4000-563501	Fjedersæt	75/150	
16	4000-563501-1	Fjedersæt	60/120	
16	4000-563501-4	Fjedersæt	105/210	
17	4000-563600	Justerring		
18	4000-376108	Låsesæt	QC t/1 3/8" nav	125
18	4000-376109	Låsesæt	QC t/1 3/4" nav	126
19	4000-165042	Kile	t/QC lås	
20	4000-341953	ZV låsesæt	t/1 3/8" nav	108
21	4000-651300	Klemring	CC, 1 3/8"	
22	4000-651210	Klemkonus	FK96 & FK96/4 t/1 3/8" nav	
23	4000-162051	Klembrohalvpart	1 3/8"	
23	4000-162099	Klembrohalvpart	1 3/4"	

April 1999

Momentindstilling Nm K96 & K96/4 fjedersæt

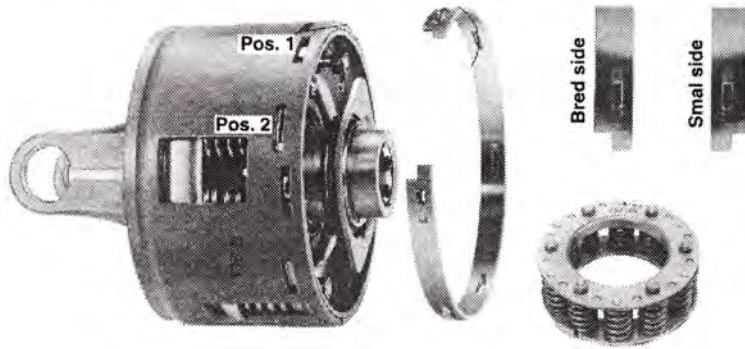

K96

Fjedersæt nr.	Udvendig fjederantal	Indvendig fjederantal	Spor 1 Pos. 1, smal	Spor 2 Pos. 1, bred	Spor 3 Pos. 2, smal	Spor 4 Pos. 2, bred
4000-563501-1	10	2	530 Nm	600 Nm	700 Nm	780 Nm
4000-563501	11	5	650 Nm	750 Nm	850 Nm	950 Nm
4000-563501-4	12	12	900 Nm	1050 Nm	1180 Nm	1300 Nm

K96/4

Fjedersæt nr.	Udvendig fjederantal	Indvendig fjederantal	Spor 1 Pos. 1, smal	Spor 2 Pos. 1, bred	Spor 3 Pos. 2, smal	Spor 4 Pos. 2, bred
4000-563501-1	10	2	1050 Nm	1200 Nm	1380 Nm	1530 Nm
4000-563501	11	5	1330 Nm	1500 Nm	1730 Nm	1900 Nm
4000-563501-4	12	12	1800 Nm	2100 Nm	2350 Nm	2600 Nm

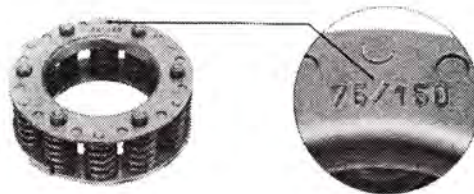

Fjedersæt har en påstempling, f.eks. 75/150.

D.v.s. i spor 2, der altid er udgangsposition, er 75 til K96 og 150 til K96/4, der henholdsvis er monteret med 2 eller 4 stk. belægning.

75 = 750 Nm

150 = 1500 Nm

Automatisk tilkobling

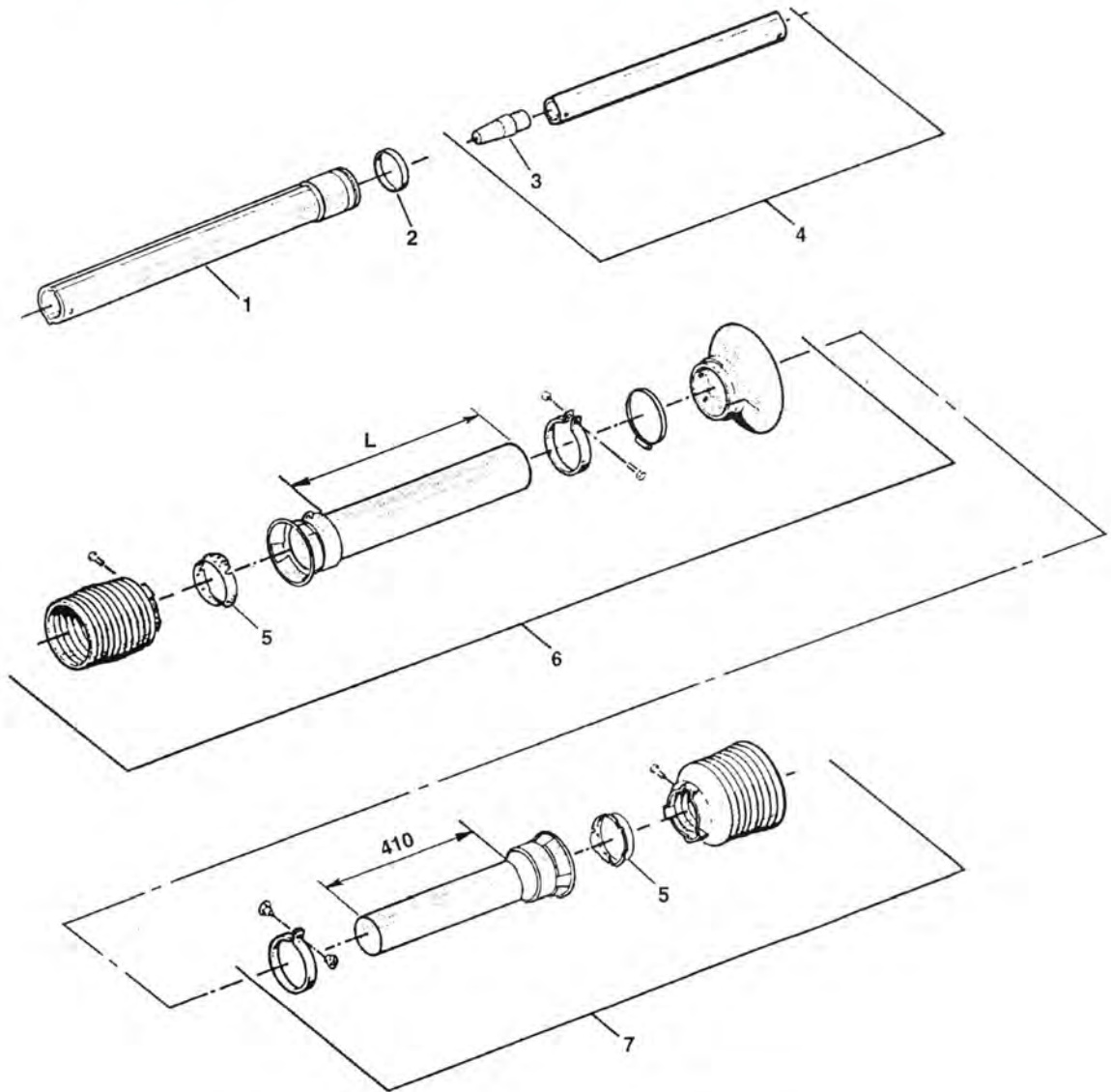

Pos.	Grp. - varenr.	Benævnelse	Bemærkninger
1	4000-7515223	Profilrør, udv.	L = 485 mm (751500) (Taarup)
2	4000-8291103	Føring	t/7515223 (751500) (Taarup)
2	4000-8291104	Føring	t/7539104-70 (753500) (JF)
3	4000-1655114	PVC-studs	t/751100 (Taarup)
3	4000-1655116	PVC-studs	t/752500 (JF)
4	4000-7511142	Profilrør, indv.	L = 485 mm (751100) (Taarup)
5	4000-828306	Ring	t/SC15 (Taarup)
5	4000-828304	Ring	t/SC25 (JF)
6	4000-85115470	Beskyttelsesrør, udv.	L = 470 mm (SC15) (Taarup)
6	4000-85115620	Beskyttelsesrør, udv.	L = 620 mm (SC15) (Taarup)
6	4000-85215450	Beskyttelsesrør, udv.	L = 450 mm (SC25) (JF)
7	4000-85114410	Beskyttelsesrør, indv.	L = 410 mm (SC15) (Taarup)
7	4000-85214390	Beskyttelsesrør, indv.	L = 390 mm (SC25) (JF)

Kpl. beskyttelsesrør med glidring

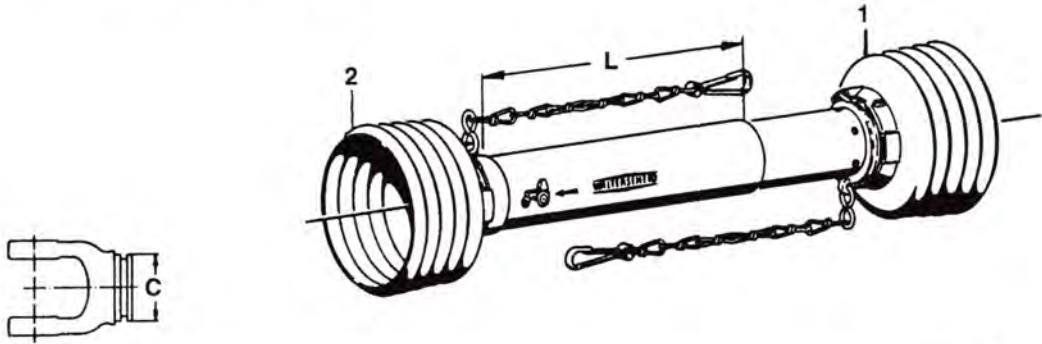

Serie	C-mål i mm	Længde i mm	1 Indv. halvpart	2 Udsv. halvpart
SD05	47	1000	4000-850041000	4000-850051000
		1500	4000-850041500	4000-850051500
SD15	58	1000	4000-851041000	4000-851051000
		1000	4000-851011000W	4000-851021000W
		1500	4000-851041500	4000-851051500
SD25	70	1000	4000-852041000	4000-852051000
		1000	4000-852041000S	4000-852051000S
		1000	4000-852011000W	4000-852021000W
		1500	4000-852041500	4000-852051500
SD35	90	1000	4000-853041000	4000-853051000

W = vidvinkel

S = hætte, 4000-852608, t/W2500 aksel

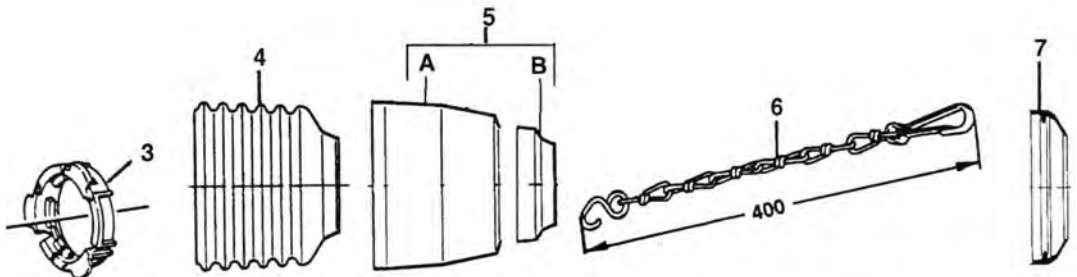

Varegruppe 4000



Serie	C-mål i mm	Udv. rør kpl.	Indv. rør kpl.	3 Glide-ring	4 Tragt m/skrue	5 Tragt t/vidvinkel	6 Holde-kæde	7 Forst. ring
SD05	47	Se ovenstående skema		830901	850504		823603	831003
SD15	58	Se ovenstående skema		828306	851506	851551	823603	828500
SD25	70	Se ovenstående skema			852507 se 1)	828410 se 3) (A)	823603	828500
						852552 (B)		
					852608 se 2)	828424 se 4) (A)	823603	828500
						852552 (B)		
SD35	90	Se ovenstående skema		828307				

- 1) t/W2400-aksel
- 2) t/W2500-aksel
- 3) A + B) t/WW2480 aksel
- 4) A + B) t/WW2580 aksel

Svejseringe til profilrør

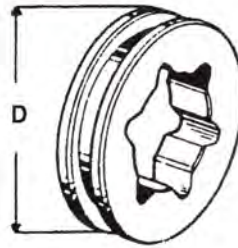
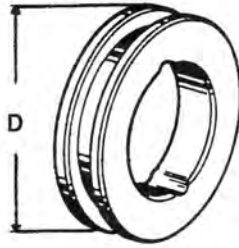
Til ny type beskyttelsesrør

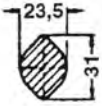
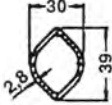
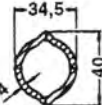
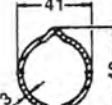

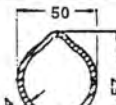
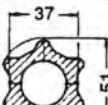
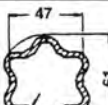
Profilrør	D	Svejsering
750600 (OOA) 	47 mm	4000-166005
751200 (OA) 		4000-166006
751100 (OV) 	58 mm	4000-1633110
751500 (1) 		4000-1633111
752500 (1B) 	70 mm	4000-1633113
753500 (2A) 		4000-1633114
753000 (2) 		4000-1633115
754400 (S-A) 		4000-1633116
754500 (1) 		4000-1633117

Tragte til beskyttelsesrør med glidering

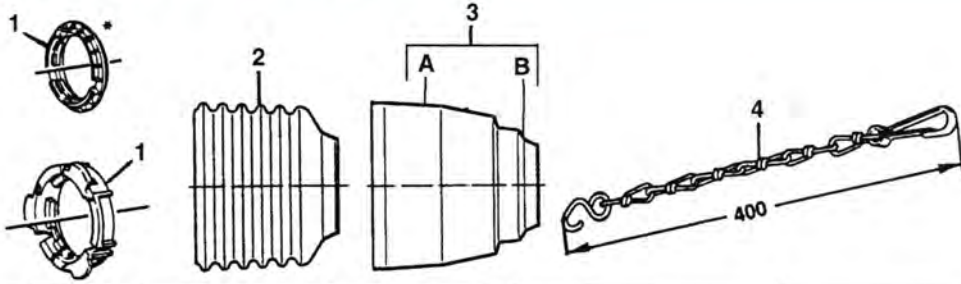

Serie	C-mål i mm	1 Glidering	2 Tragt	3 Tragt til vidvinkel	4 Holde-kæde
SC04	47	4000-830900*			4000-823603
SC14	58	4000-828306	4000-851506	4000-851551	4000-823603
SC24	70	4000-828304	4000-852608	4000-828410 (A) (1) 4000-852552 (B)	4000-823603
				4000-828424 (A) (2) 4000-852552 (B)	

1) A + B) t/WW2480 aksel
2) A + B) t/WW2580 aksel

Tragte til beskyttelsesrør - vidvinkel 80 grader

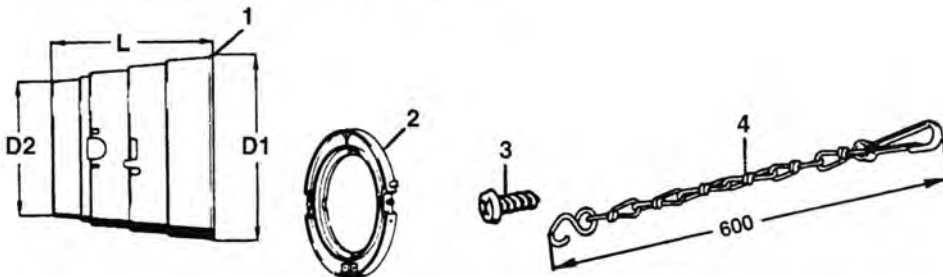

Serie	1 Tragt	2 Ring	3 Skrue (6 stk.)	Længde (L) i mm	D1 mm	D2 mm	4 Holde- kæde
WW2280	4000-850000-1	4000-828312	4000-601500	153	182	142	4000-823608
WW2380	4000-850001-1	4000-828313	4000-601500	172	202	156	4000-823608
WW2480	4000-850002	4000-828314	4000-601500	188	222	159	4000-823608
WW2580	4000-850003	4000-828315	4000-601500	201	237	173	4000-823608

* Komplette beskyttelsesrør : se side 4.039!

47 mm beskyttelsesrør, plastik med 2-delt kuglering



C-mål i mm	1 Spændebånd	2 Kugleskål	3 Kuglering	4 Kugle	5 Holdekæde
47	4000-830701	4000-830000	4000-830601	7500-RB 07	4000-823603

47 mm beskyttelsesrør, plastik med kuglering

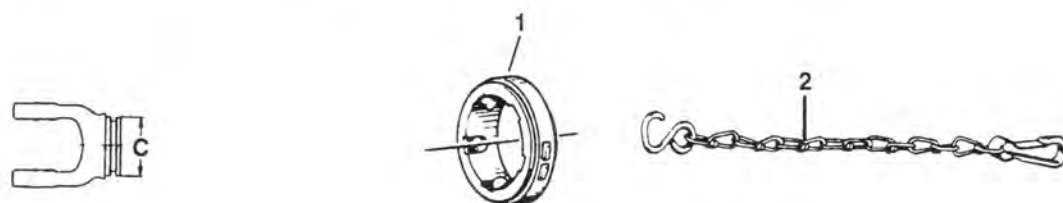

C-mål i mm	1 Kuglering	2 Holdekæde
47	4000-830801	4000-823603

58 & 70 mm beskyttelsesrør, plastik med kuglering

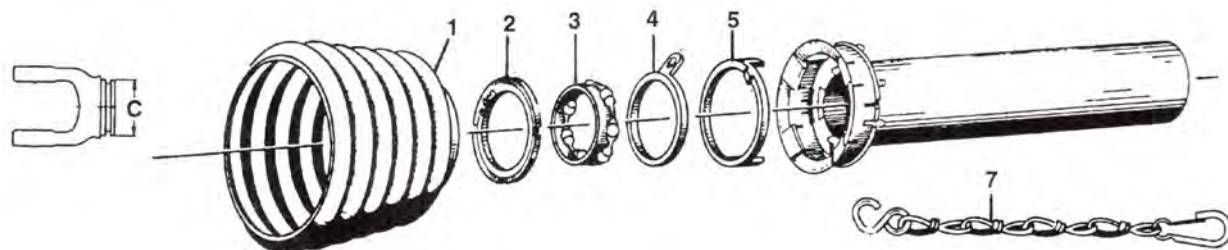

C-mål i mm	1 Tragt til vidvinkel	2 Notring	3 Kuglering	4 Holdering	5 Låserring	7 Holdekæde
58		4000-829300	4000-829601	4000-829302	4000-829301	4000-823603
70	4000-828410 + 4000-828409	4000-828300	4000-828601		4000-828301	4000-823603

Komplette kraftoverføringsaksler

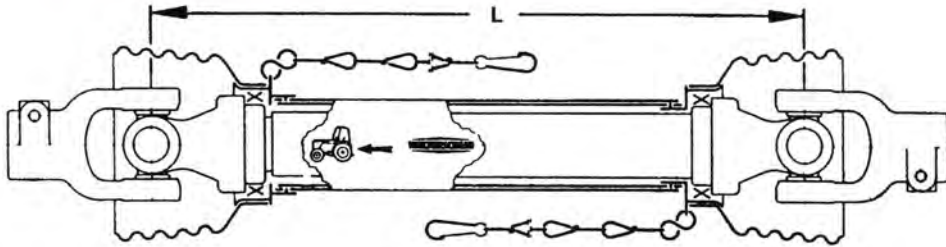

L = sammenskudt længde fra midt kryds til midt kryds

Type	Kryds	540 omdr./min.			
		Konstant belastning		Svingende belastning	
		Effekt		Effekt	
		Kw	Hk	Kw	Hk
W2100	100100	9	12	15	21
W2200	200000	15	21	26	35
W2300	210000	21	29	39	53
W2400	350000	30	41	57	78
W2500	360000	50	68	96	135

Type	Kryds	1000 omdr./min.			
		Konstant belastning		Svingende belastning	
		Effekt		Effekt	
		Kw	Hk	Kw	Hk
W2100	100100	14	19	28	38
W2200	200000	24	32	48	66
W2300	210000	33	45	72	98
W2400	350000	46	63	106	144
W2500	360000	77	105	184	250

Type	Kryds	Længde (L) i mm	Grp.- varenr.	Traktorside	Redskabsside
W2100	100100	560	4010-921271-2	1 3/8" - 6	Konus Ø25 - Hardi
W2100	100100	560	4010-921271-3	1 3/8" - 6	Konus Ø30 - Hardi
W2100	100100	860	4010-A20412/13	1 3/8" - 6	1 3/8" - 6
W2200	200000	860	4010-A22415/444	1 3/8" - 6	K92, 1 3/8" - 6, 750 Nm
W2200	200000	860	4010-A22415/445	1 3/8" - 6	Boltekobling
W2300	210000	860	4010-A23412/13	1 3/8" - 6	1 3/8" - 6
W2300	210000	860	4010-A23412/445	1 3/8" - 6	8 mm boltekobling
W2400	350000	610	4010-A24901	1 3/8" - 6	K90/4, 1 3/4" - 6, 1300 Nm
W2400	350000	860	4010-A24412/13	1 3/8" - 6	1 3/8" - 6

Komplette halvparter

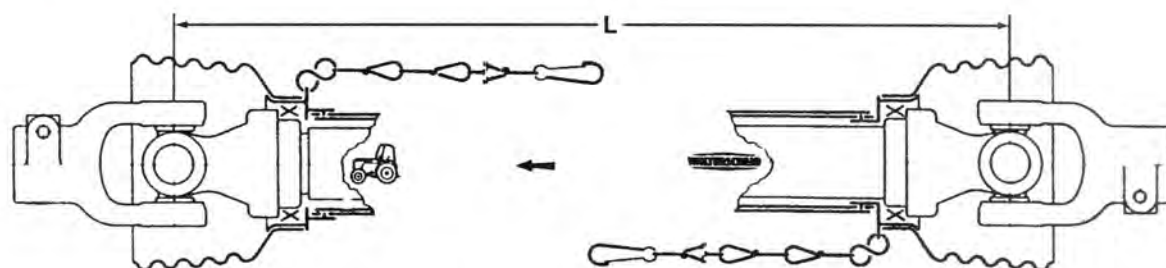

L = sammenskudt længde fra midt kryds til midt kryds

Type	Kryds	Længde (L) i mm	Grp.- varenr.	Traktorside - indvendig	Redskabsside - udvendig
W2100	100100	860	4010-A21412	1 3/8" - 6	
W2100	100100	860	4010-A21413		1 3/8" - 6
W2100	100100	860	4010-A21443		K32, 1 3/8" - 6
W2100	100100	860	4010-A21472	1 1/8" - 6	
W2100	100100	860	4010-A21473		1 1/8" - 6
W2100	100100	1210	4010-A21612	1 3/8" - 6	
W2100	100100	1210	4010-A21613		1 3/8" - 6
W2200	200000	860	4010-A22415	1 3/8" - 6	
W2200	200000	860	4010-A22416		1 3/8" - 6
W2200	200000	1010	4010-A22515	1 3/8" - 6	
W2200	200000	1010	4010-A22516		1 3/8" - 6
W2200	200000	1210	4010-A22615	1 3/8" - 6	
W2200	200000	1210	4010-A22616		1 3/8" - 6
W2300	210000	860	4010-A23412	1 3/8" - 6	
W2300	210000	860	4010-A23413		1 3/8" - 6
W2300	210000	1010	4010-A23543		K33, 1 3/8" - 6
W2300	210000	1210	4010-A23612	1 3/8" - 6	
W2300	210000	1210	4010-A23613		1 3/8" - 6
W2400	350000	710	4010-A24343		K92/4, 1050 Nm
W2400	350000	860	4010-A24412	1 3/8" - 6	
W2400	350000	860	4010-A24413		1 3/8" - 6
W2400	350000	1010	4010-A24512	1 3/8" - 6	
W2400	350000	1010	4010-A24513		1 3/8" - 6
W2400	350000	1010	4010-A24543-1		F5/1 friløb
W2400	350000	1210	4010-A24612	1 3/8" - 6	
W2400	350000	1210	4010-A24613		1 3/8" - 6
W2500	360000	560	4010-A25212	1 3/8" - 6	
W2500	360000	560	4010-A25213		1 3/8" - 6
W2500	360000	710	4010-A25312	1 3/8" - 6	
W2500	360000	710	4010-A25313		1 3/8" - 6
W2500	360000	860	4010-A25412	1 3/8" - 6	
W2500	360000	860	4010-A25413		1 3/8" - 6

Indv. halvpart er med indv. profilrør og udv. beskyttelsesrør

Komplette kraftoverføringsaksler - vidvinkel

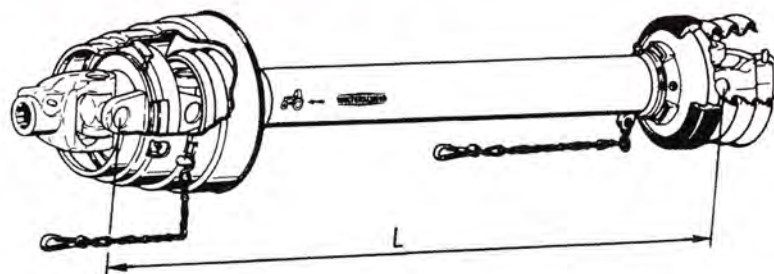

Type	Kryds	Længde (L) i mm	Grp.- varenr.	Traktorside	Redskabsside
W2380	210000	1210	4010-A68623/632	1 3/8" - 6	1 3/8" - 6
W2480	350000	1210	4010-A72623/632	1 3/8" - 6	1 3/8" - 6
W2480	350000	1010	4010-A72523/532	1 3/8" - 6	1 3/8" - 6 - FK 96/4, Fri/friktionskobling

W2580

360000

Se under komplette halvparter - vidvinkel

Komplette halvparter - vidvinkel

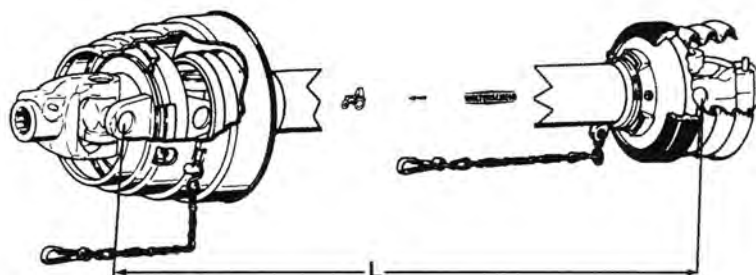

L = sammenskudt længde fra midt kryds til midt kryds

Type	Kryds	Længde (L) i mm	Grp.- varenr.	Vidvinkel traktorside - indvendig	Redskabsside - udvendig
WW2380	210600	1210	4010-A68632	1 3/8" - 6	
WW2380	210000	1210	4010-A68623		1 3/8" - 6
WW2480	350600	1210	4010-A72632	1 3/8" - 6	
WW2480	350600	1210	4010-A72633		1 3/8" - 6 - vidvinkel 351010
WW2480	350600	1210	4010-A72634	1 3/8" - 21	
WW2480	350000	1210	4010-A72623		1 3/8" - 6
WW2580	360600	1210	4010-A76632	1 3/8" - 6	
WW2580	360600	1210	4010-A76634	1 3/8" - 21	
WW2580	360000	1210	4010-A76623		1 3/8" - 6

Indv. halvpart er med indv. profilrør og udv. beskyttelsesrør

Overgangsbøsninger

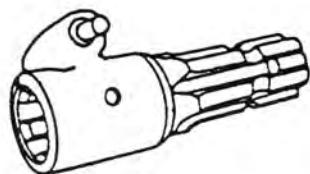

Med snaplås

Grp.- varenr.	Hul	Not	Udv. tap	Not	Længde i mm
4050-01001	1 1/8"	6	1 3/8"	6	143
4050-01002	1 3/8"	6	1 1/8"	6	150
4050-01010	1 3/8"	21	1 3/8"	6	160
4050-01011	1 3/8"	6	1 3/8"	21	150
4050-01458	1 3/4"	6	1 3/8"	6	170
4050-01459	1 3/4"	20	1 3/8"	6	175

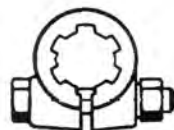

Med klembolt

Grp.- varenr.	Hul	Not	Udv. tap	Not	Længde i mm
4050-01026	1 1/8"	6	1 3/8"	21	160
4050-01027	1 3/8"	21	1 3/8"	6	160
4050-01460	1 3/4"	20	1 3/8"	21	178

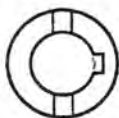

Med rundt hul

Grp.- varenr.	Hul		Udv. tap	Not	Længde i mm
4050-01028	Ø30		1 3/8"	6	150
4050-01029	Ø35		1 3/8"	6	170

Forlængerbøsninger

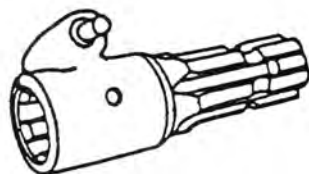

Grp.- varenr.	Hul	Not	Udv. tap	Not	Længde i mm
4050-01012 3)	1 1/8"	6	1 3/8"	6	160
4050-01021 1)	1 3/8"	6	1 3/8"	6	160
4050-01025 2)	1 3/8"	6	1 3/8"	6	160
4050-01037 1)	1 3/8"	21	1 3/8"	21	160

Snaplås kpl. t/4050-01021: 4050-01030

- 1) 4050-01021 er med snaplås
- 2) 4050-01025 er med klembolt
- 3) 4050-01012 er til rørstift

Bøsning med krave



Grp.- varenr.	Hul	Not	Udv. tap	Not	Længde i mm
4050-01014	1 1/8"	6	1 3/8"	6	76

Overgangs- og forlængerbøsninger er fremstillet af stål 45, d.v.s. under chockbelastninger max. 35 - 40 Hk.

Profilnav

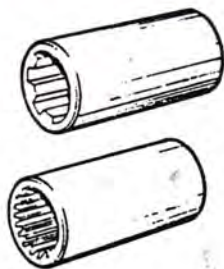

Grp.- varenr.	Hul	Not	Udv. i mm	Længde i mm
4050-01610	1 1/8"	6	39	60
4050-01611	1 1/8"	6	39	60
4050-01612	1 3/8"	6	44	95
4050-01613	1 3/8"	21	44	95
4050-01615	1 3/8"	6	49	130
4050-01614	1 3/4"	6	59	100

Nottappe - kval. CK 45

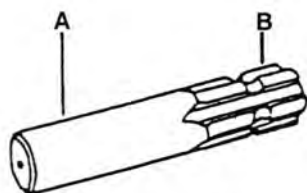

	A	B	
4050-82000200	Nottap	Ø30 mm x 1 1/8" not	L = 200 mm
4050-82100200	Nottap	Ø35 mm x 1 3/8" not	L = 200 mm
4050-82100400	Nottap	Ø35 mm x 1 3/8" not	L = 400 mm
4050-82100800	Nottap	Ø35 mm x 1 3/8" not	L = 800 mm
4050-821001000	Nottap	Ø35 mm x 1 3/8" not	L = 1000 mm
4050-82300400	Nottap	Ø40 mm x 1 3/8" not	L = 400 mm

Notaksler

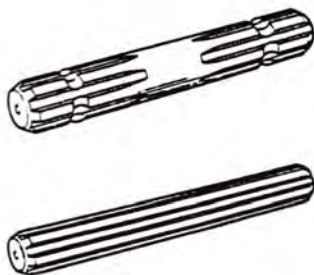

4050-82200400	Notaksel	1 3/8" - 6 not + 1 3/8" - 6 not	L = 200 mm
4050-82200800	Notaksel	1 3/8" - 6 not + 1 3/8" - 6 not	L = 800 mm
4050-14931	Aksel m/gennemgående	1 1/8" - 6 not	pr. cm
4050-149330500	Aksel m/gennemgående	1 3/8" - 6 not	L = 500 mm
4050-149331000	Aksel m/gennemgående	1 3/8" - 6 not	L = 1000 mm

Beskyttelseskærme

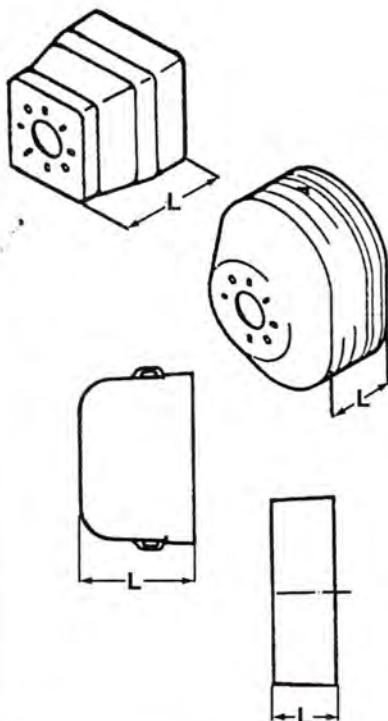

4050-84050	Beskyttelseskærm, gul, firkantet	L = 180 mm
4050-84060	Beskyttelseskærm, gul, oval	L = 150 mm
4050-21903	Beskyttelseskærm, sort	L = 160 mm
4050-21904	Beskyttelseskærm, sort	L = 180 mm
4050-21923	Forlængerbånd t/21904, gul	L = 100 mm

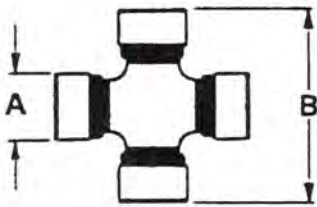
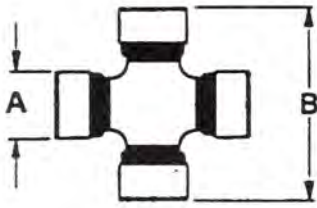
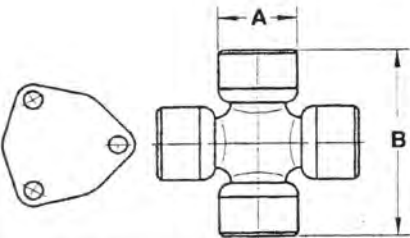
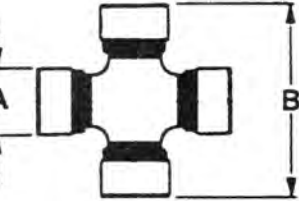
Uoriginale nålelejekryds 			A mm	B mm
	4075-GUW10		22,00	55,00
	4075-GUW11		27,00	70,00
	4075-GUW12		34,00	90,00
	4075-GUW20		24,00	61,00
	4075-GUW21		27,00	74,50
	4075-GUW22		30,00	92,00
	4075-GUW24		35,00	106,50
Diverse kryds  		Orig. nr.	A mm	B mm Anvendes på:
	4075-H18901		19,00	52,00
	4075-H0035		19,04	51,96
	4075-H0050		23,80	61,30
	4075-H7284		24,00	74,50
	4075-H0110		26,97	74,60
	4075-H0178		27,00	80,00
	4075-GUY1000		27,00	81,75
	4075-H0706		29,00	75,40
	4075-GUW3041		29,00	80,00
	4075-H0220		30,18	92,07
	4075-H18200		30,18	106,28
	4075-32086	3958381	32,00	86,00
	4075-12255		35,00	96,80
	4075-H0744		38,00	105,80
	4075-14289		39,00	113,00
	4075-H0350		39,70	105,80
	4075-17839		50,00	152,60
				C-type 1140, Højbjerg, Hardi
				Nittekryds, Mercedes
				Volvo
				Nittekryds, VW LT
				C-type 1310, Højbjerg
				Opel
				Ama pressere
				Ford rendegravere
				Champion
				ZF forvogn 6710, 7610, 7710
				Forhjulstræk på traktorer
				Volvo 814 & 2654
				Kryds med låseplader
Nålelejekryds til Bogense 			A mm	B mm
	4100-71080		22,00	56,00
	4100-21080		25,00	73,50
	4100-401080		27,00	76,00
	4100-31080		30,00	82,50

WKS hurtigkoblingsæt



a
Gribeklo

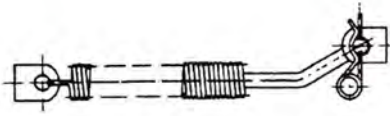

b
Afstandsholder

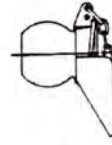

c
Kugle-/styrekegle



d
Reduktionsbøsning



e
Kuglebøsning

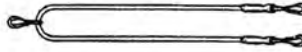

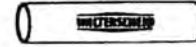

f
Betjeningskabel



g
Elektrode

Grp.- varenr.	Benævnelse	Kat	Indhold	Traktor- størrelse
4060-200050	Gribeklosæt	2	2 stk. a 1 stk. b 4 stk. c kat. 2 2 stk. d kat. 1/2 2 stk. e kat. 2 1 stk. f 1 stk. g	60 til 100 Hk
4060-200052	Gribeklosæt	3	2 stk. a 1 stk. b 4 stk. c kat. 3/2 2 stk. e kat. 3/2 1 stk. f 1 stk. g	100 til 184 Hk

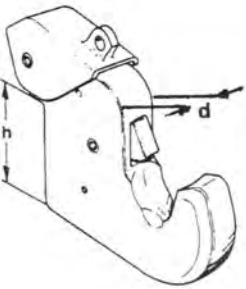
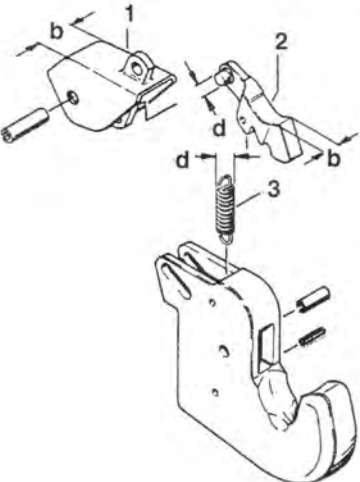
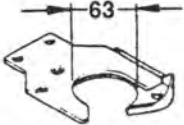
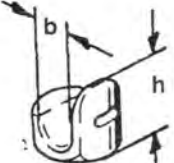
WKS

	Grp.- varenr.	Kat.	b	d	h	Benævnelse
	4060-306257 1)	2L	45*			Låsebeslag
	4060-306103 1)	2	45*			Låsebeslag
	4060-306104 1)	3	49*			Låsebeslag
	4060-99474 2)	3	18	12,0		Spærretap t/kugle
	4060-99478 2)	2	16	12,0		Spærretap t/kugle
	4060-305236 2)	2L	16	10,0		Spærretap t/kugle
	4060-99481 3)	2 + 3		14,6		Trykfjeder t/spærretap
	4060-305126 3)	2L		14,0		Trykfjeder t/spærretap
	4060-96045	2				Holder t/topstang
	4060-86627	2	29		50	Foring t/gribeblo
	4060-82778	2	29		58	Foring t/gribeblo
	4060-305393					Betjeningskabel t/trækarme, L = 3,5 m
	4060-305451					Betjeningskabel t/trækarme, L = 4,0 m
	4060-305392					Betjeningskabel t/topstang, L = 1,5 m

* Indv. mål

WKS

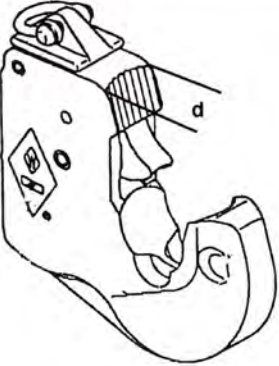
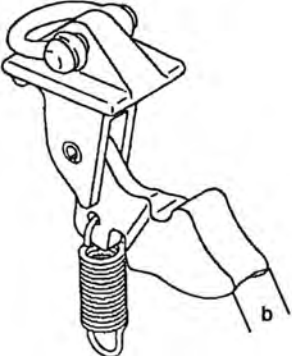
	Grp.- varenr.	Kat.	b	d	h	Benævnelse
	4060-200016	2		35		Gribeklo, løs
	4060-200020	3		40		Gribeklo, løs
	4060-200001	2	16			Låsekilesæt
	4060-200002	3	18			Låsekilesæt

WKS

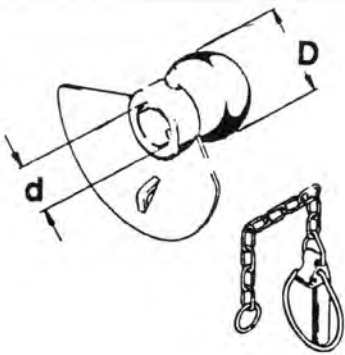
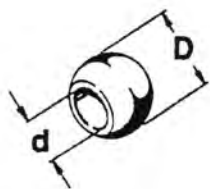
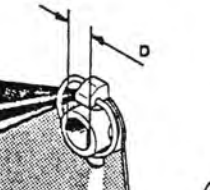
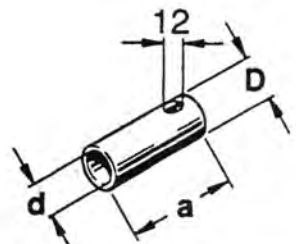
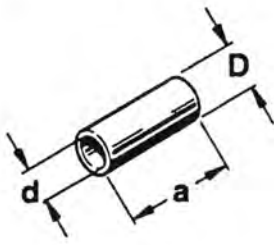
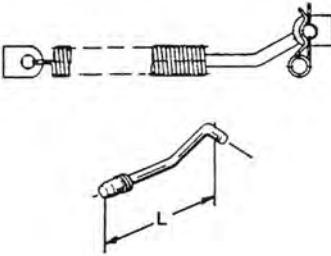
	Grp.- varenr.	Kat.	D	d	a	Benævnelse
	4060-99032 4060-99035 4060-99034 4060-99033 4060-305855 4060-305854	2 3/2 3 3 1/2/3 3	56 64 64 64 56 64 64 50 60 60	28,4 28,4 37,0 37,0 28,4 28,4 25,4 25,4 32,0		Kugle m/styrekegle Kugle m/styrekegle Kugle m/styrekegle & 12 mm ringsplit Kugle m/styrekegle & 17 mm ringsplit Ringsplit t/styrekegle, 12 mm Ringsplit t/styrekegle, 17 mm Kuglebøsning t/trækarm Kuglebøsning t/trækarm Kuglebøsning t/trækarm Kuglebøsning t/topstang Kuglebøsning t/topstang Kuglebøsning t/topstang
	4060-82646 4060-95409	2 1 & 2	28 28			Styrekegle Ringsplit t/styrekegle
	4060-82651 4060-305281	2/1 3/2	28 37	22,4 28,4	63 62	Reduktionsbøsning t/trækarm Reduktionsbøsning t/trækarm Reduktionsbøsning t/trækarm Reduktionsbøsning t/topstang Reduktionsbøsning t/topstang
	4060-305279 4060-305280 4060-82649 4060-305278	2/1 3/2 2/1 3/2	28 37 25 32	22,4 28,4 19,5 25,4	45 45 44 51	Reduktionsbøsning t/trækarm Reduktionsbøsning t/trækarm Reduktionsbøsning t/trækarm Reduktionsbøsning t/topstang Reduktionsbøsning t/topstang
	4060-84734 4060-88202	* 				Afstandholder, justerbar Arm m/bøsning, L = 292 mm

Hydrauliske topstænger til WKS

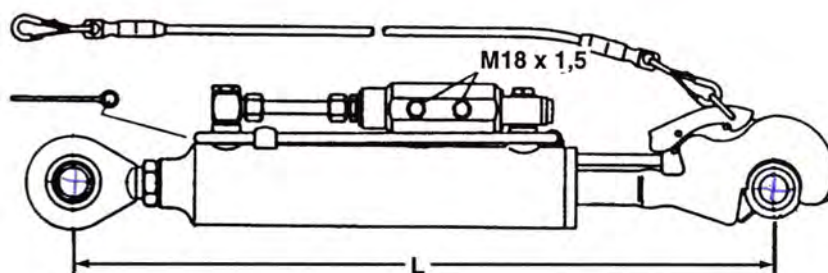

Grp.- varenr.	Kat	Spændevide	Traktorstørrelse
4060-305944	2	595 - 825 mm	> 100 Hk
4060-305945	3/2	640 - 880 mm	> 184 Hk

Reservedele til WKS

	Grp.- varenr.	Kat.	b	d	Benævnelse
<p>Pakningssæt</p>	4060-306086	2			Pakningssæt, Ø30, Agraset 319
	4060-99456	2			Palsæt t/gribeklo t/topstang, Ø22 mm
	4060-99455	2	26	40,0	Foringsæt t/gribeklo t/topstang
	4060-305837	2		25,4	Gribeklo t/påsvejsning t/topstang
	4060-305032	2			Låsearm t/topstang

Dele passende til

Taarup



Rekvirer venligst vort specialkatalog!